

PRODUCT INFORMATION MODEL 1041 CABALLERO

© 2015 KURT BEIER & KATI QUINGER



A light covered plateau with high-quality metal feet, optionally available in different surfaces



Functional back with high-quality back cushions









Inserted soft comfort seat cushions

CABALLERO: A STRONG CHARACTER COMBINED WITH CLEAN, FINE DESIGN. THE CUBIC SHAPE UNDERLINES THE STRAIGHT LINE, SOFTLY BROKEN BY INSERTABLE CUSHIONS AND BY THE SPECIAL DESIGN OF THE ARMRESTS. BACK ELEMENTS INDIVIDUALLY ADJUSTABLE FOR INDIVIDUAL SEATING COMFORT. STEEL BASE OPTIONALLY IN TWO HEIGHTS AND THREE SURFACES. AVAILABLE IN EXCELLENT LEATHERS AND POWERFUL FABRICS.

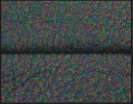
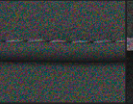
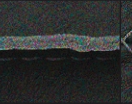

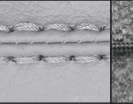
Metallfeet: matt black / stainless steel finish
Height: 18 cm / **Floor distance:** approx. 18 cm
optionally (extra charge) 20 cm foot / **Floor distance:** approx. 20 cm

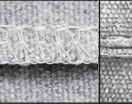
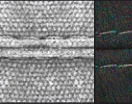
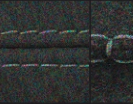
Processing options of main seam / decorative seam

	Plain seam	Lap seam	Raw edged	Moccasin seam extra charge	Twin seam extra charge	KR* (zipper piping) extra charge	Overcast seam extra charge	Piping	Two needle seam	Square seam extra charge
										
Fabric		x								
Leather		x	x							
Fur										
Fake fur	x									

It is possible to order main seam or decorative seam either tone in tone like the colours of cover or in the contrasting colours white, nature, grey, rust and black. On request special colours possible.

***Zipper piping:** optionally in the colours black, red, nature or light grey.

Variations, feet:



Metal base, matt black



Metal base, stainless steel finish

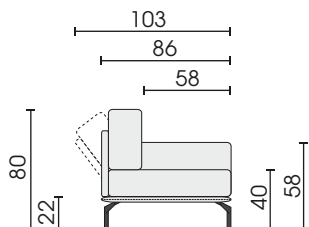

Side view (18 cm feet)

▷ = Connector side

◻ = Label

Elements:

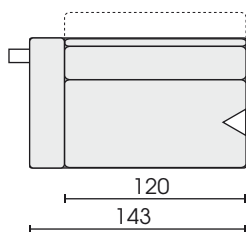

Sofa 2-seat
armrest left
220

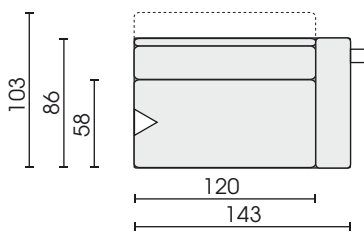

Sofa 2-seat
armrest right
210

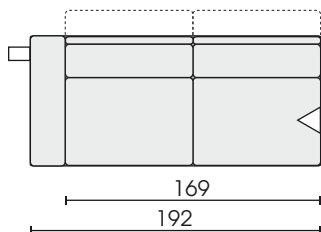

Sofa 2,5-seat
armrest left
258

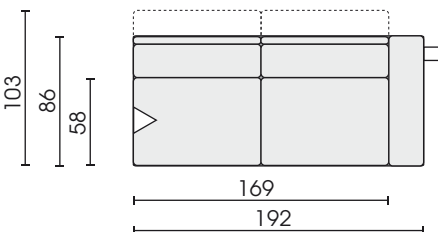

Sofa 2,5-seat
armrest right
257

Each piece of furniture is handmade and unique. Deviations to the listed measurements may be caused by:
1. different upholstery materials (fabric, leather), 2. processing of ticking mats, 3. the pressure to combine individual parts, etc.
The seat comfort of a sofa type with larger seat depth usually differs from one with lower depth.

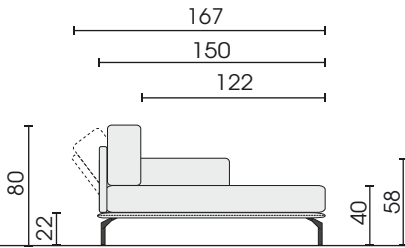

Side view (Type 441 / 18 cm feet)

▷ = Connector side

□ = Label

Elements:

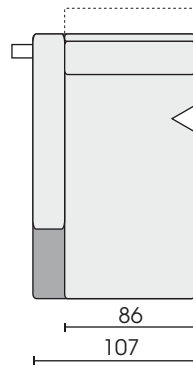

Recamier
armrest left
420

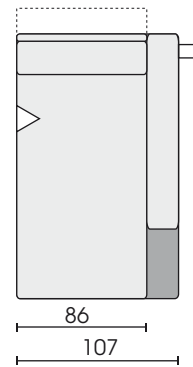

Recamier
armrest right
410

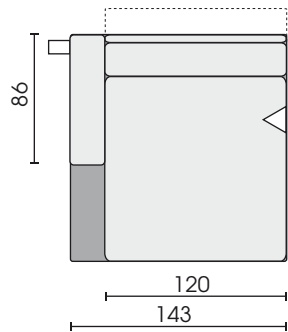

Recamier wide
armrest left
442

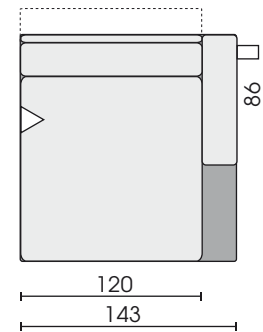

Recamier wide
armrest right
441

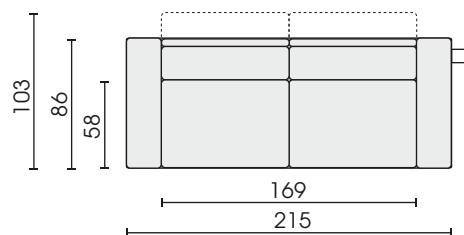

Sofa 2,5-seat 2 armrests
240

Each piece of furniture is handmade and unique. Deviations to the listed measurements may be caused by:
1. different upholstery materials (fabric, leather), 2. processing of ticking mats, 3. the pressure to combine individual parts, etc.
The seat comfort of a sofa type with larger seat depth usually differs from one with lower depth.

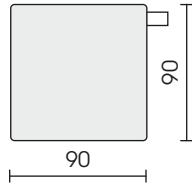

Stool
540

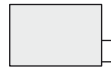

Cushion
(Tapered cushion)
(Plain seam)
60 x 40
967

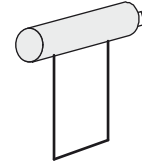

Head-rest
to plug in
Ø=18 L=66
640

Slide table model 1117, solid wood (available in different wood types):

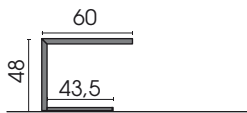

Side view
(type 866)

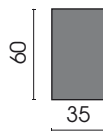
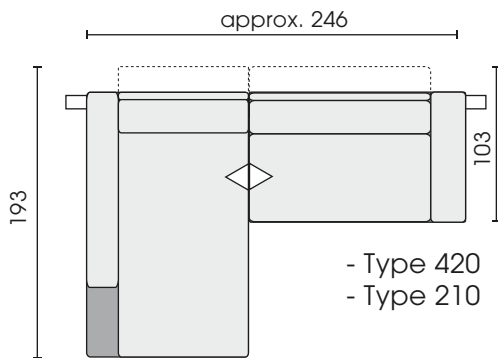
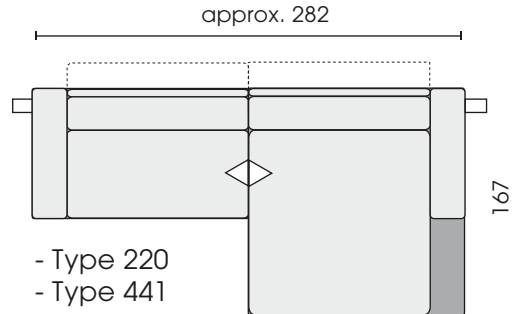

Table
to push
866

Each piece of furniture is handmade and unique. Deviations to the listed measurements may be caused by:
1. different upholstery materials (fabric, leather), 2. processing of ticking mats, 3. the pressure to combine individual parts, etc.
The seat comfort of a sofa type with larger seat depth usually differs from one with lower depth.

Combinations:



364
Corner combination (small)
left

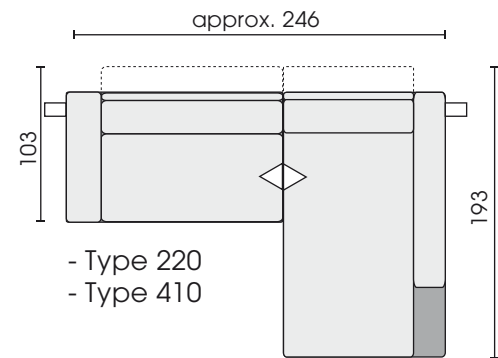

363
Corner combination (small)
right

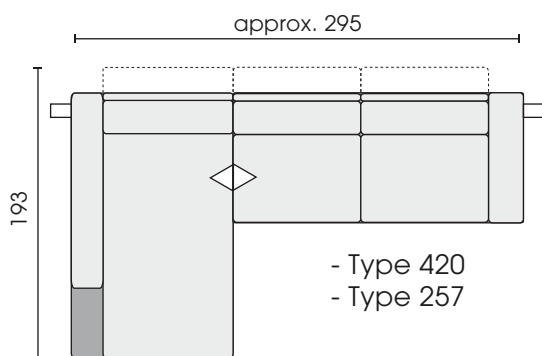

368
Corner combination (large)
left

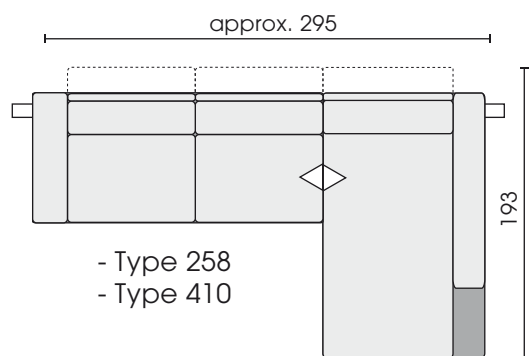

367
Corner combination (large)
right

Each piece of furniture is handmade and unique. Deviations to the listed measurements may be caused by:
1. different upholstery materials (fabric, leather), 2. processing of ticking mats, 3. the pressure to combine individual parts, etc.
The seat comfort of a sofa type with larger seat depth usually differs from one with lower depth.