

PRODUCT INFORMATION MODEL 1001 CAMP

© 2009 KURT BEIER & KATI QUINGER



High quality seams



Comfortable back cushions



Seat depth adjustment via stainless steel switch at the armrest



CAMP: ONE OF A KIND

VERSATILE SOFA RANGE THAT CAN BE COMBINED IN MANY WAYS. AN „ARCHETYPE“. CLASSIC COMBINATION OF FORM AND FUNCTION, MATERIAL AND WORKMANSHIP. SEAT DEPTH OF THE ARMREST ELEMENTS ADJUSTABLE MOTORDRIVEN UP TO 25 cm. MASCULINE LINE WITH STRONG UPHOLSTERY AND DISTINCTIVE, HANDCRAFTED SEAMS. COVERS (LEATHER AND FABRIC) AS WELL AS SEAM VARIATIONS ARE AVAILABLE. UNIQUE PIECE PRODUCTION.

Feet: 5 cm, plastic glides
Floor distance: approx. 5 cm

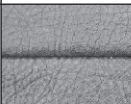
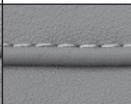
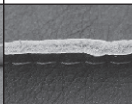
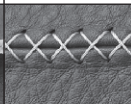
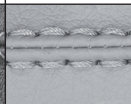

Processing options of main seam / decorative seam

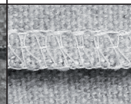
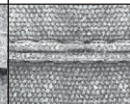
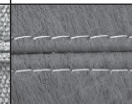
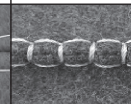
	Plain seam	Lap seam** Standard	Raw edged	Moccasin seam*** extra charge	Twin seam extra charge	KR* (zipper piping) extra charge	Overcast seam extra charge	Piping	Two needle seam	Square seam extra charge
										
Fabric		x		x						
Leather**		x		x						
Fur										
Fake fur										

It is possible to order main seam or decorative seam either tone like the colours of cover or in the contrasting colours white, nature, grey, rust and black. On request special colours possible.

*Zipper piping: optionally in the colours black, red, nature or light grey.

**With lap seam the dividing seams are made with two-needle seam.

***With Moccasin seam the dividing seams are made with plain seam.

Version for motorised drive:

- handset switch
- power supply

Processing options of seam:

Standard option

Main seams at seat, back and armrest with lap seam, either tone in tone or contrasting colour possible.

With lap seam dividing seams at seat and back are stitched, either tone in tone or contrasting colour possible.

Option with Manufact seam Moccasin (for an extra charge)

Main seams at seat, back and armrest with Manufact seam Moccasin with contrasting colour.

With Manufact seam Moccasin dividing seams at seat and back are plain seam (without decorative seam).

24.04.2023

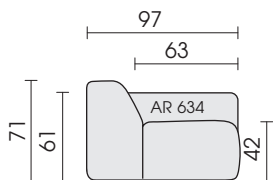

Side view

▷ = Connector side

Elements with 63 cm seat depth

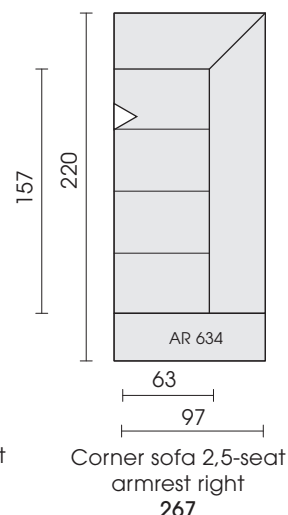
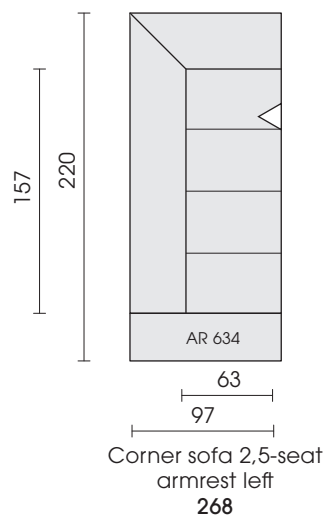
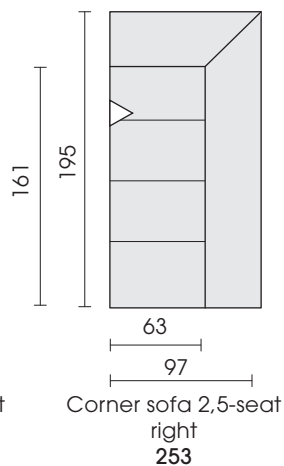
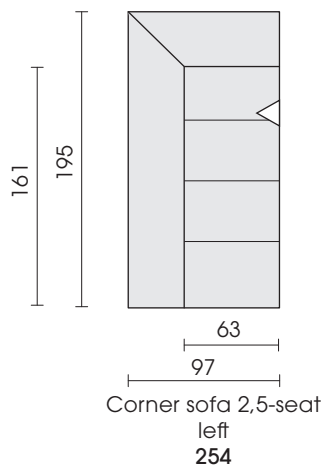
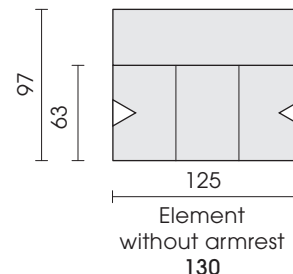
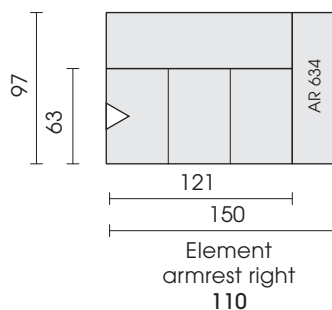
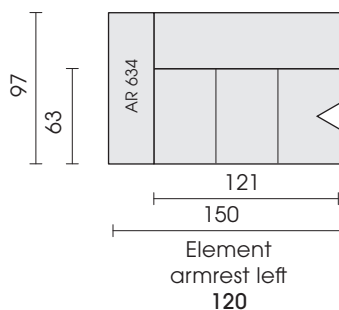
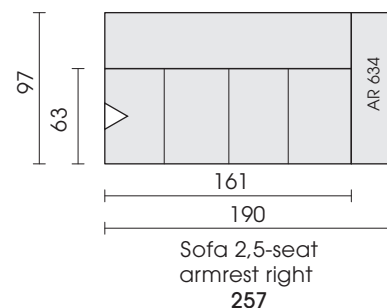
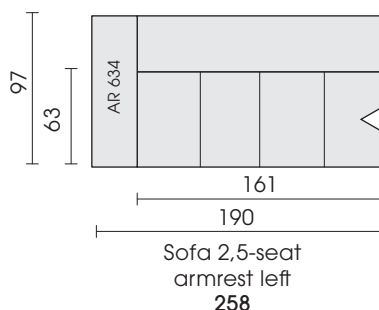
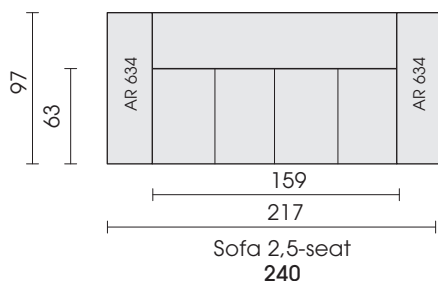

Each piece of furniture is handmade and unique. Deviations to the listed measurements may be caused by:
 1. different upholstery materials (fabric, leather), 2. processing of ticking mats, 3. the pressure to combine individual parts, etc.
 The seat comfort of a sofa type with larger seat depth usually differs from one with lower depth.

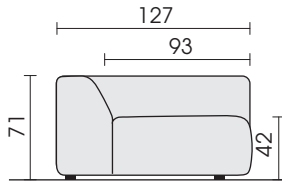

Side view

▷ = Connector side

Sofas with 91 cm seat depth

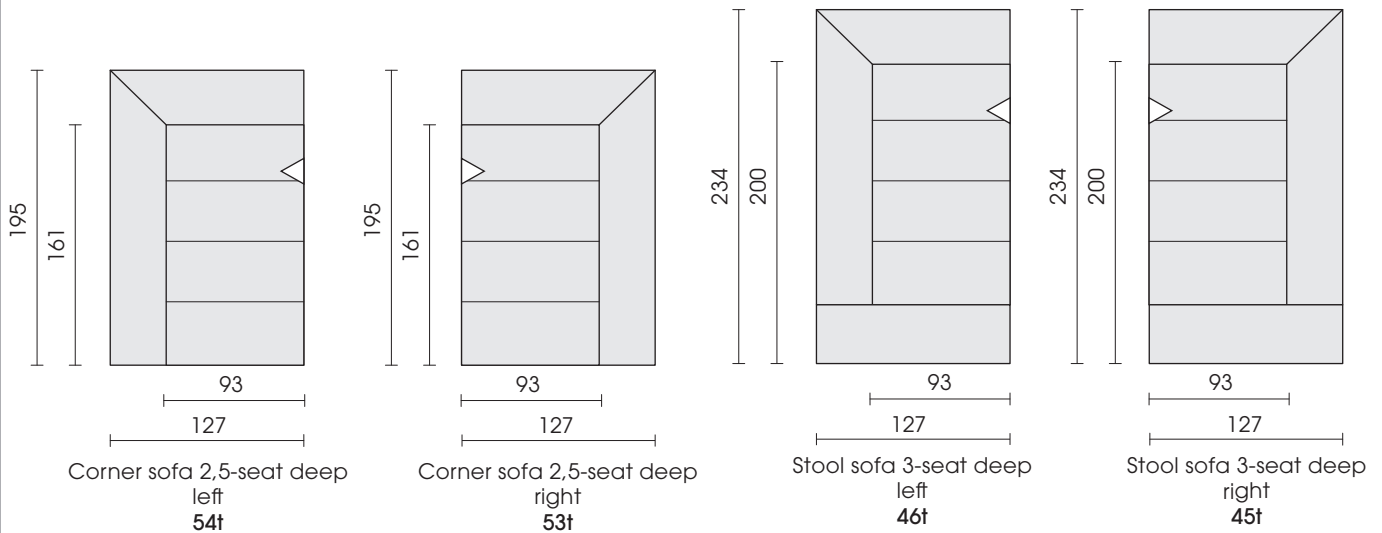

Stool

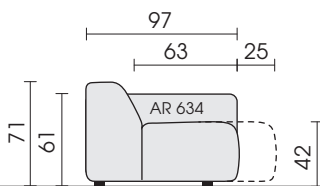
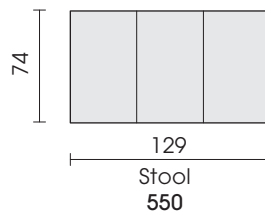

Side view

▷ = Connector side

Sofas with motorised seat extension

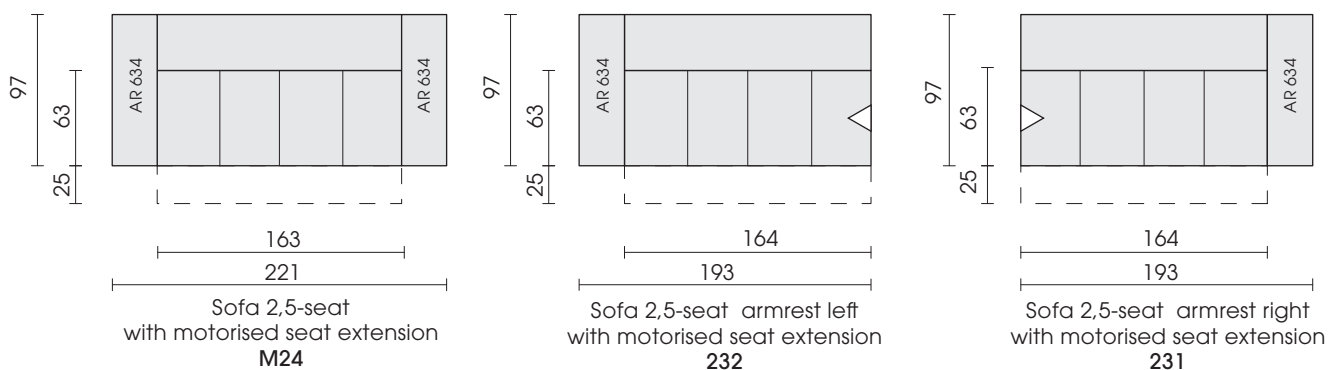

Each piece of furniture is handmade and unique. Deviations to the listed measurements may be caused by:
 1. different upholstery materials (fabric, leather), 2. processing of ticking mats, 3. the pressure to combine individual parts, etc.
 The seat comfort of a sofa type with larger seat depth usually differs from one with lower depth.

Elements with motorised seat extension

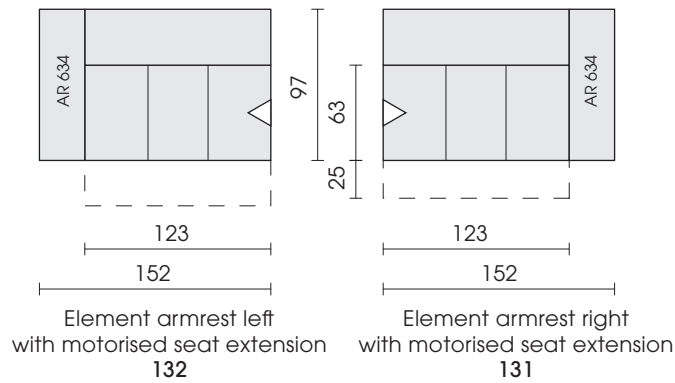

Cushions with decorative seams are either tone in tone or contrasting colour possible.

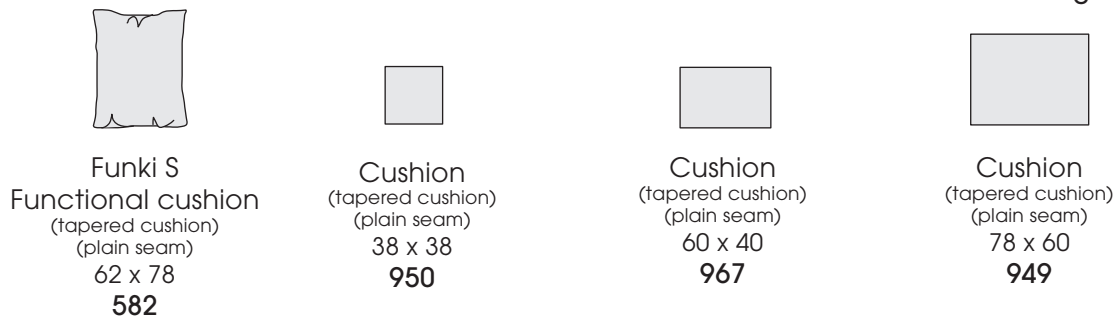

Combinations

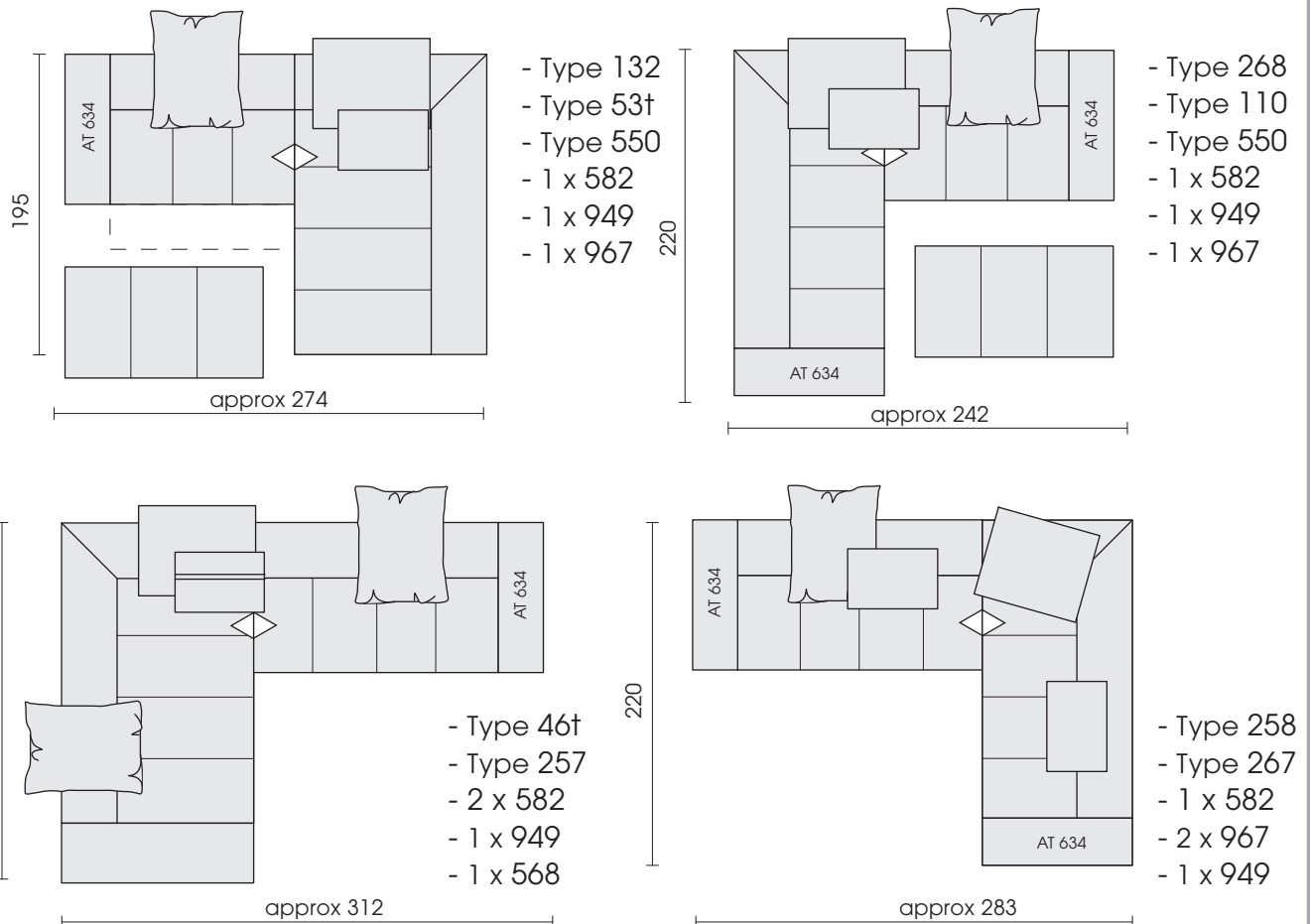

Each piece of furniture is handmade and unique. Deviations to the listed measurements may be caused by:
1. different upholstery materials (fabric, leather), 2. processing of ticking mats, 3. the pressure to combine individual parts, etc.
The seat comfort of a sofa type with larger seat depth usually differs from one with lower depth.