

PRODUCT INFORMATION MODEL OD1037 LETTINO

© 2011 KURT BEIER & KATI QUINGER



www.bullfrog-design.com

Lounger Lettino with intermediate table



Functional lounger Lettino, single or...



...as comfort double lounger



Lettino chair with and without stool





Flexibility due to practical castors

OD LETTINO: FLOAT ON A CLOUD. OUTDOOR GARDEN LOUNGER AND ARMCHAIR WITH SOFT UPHOLSTERY ON A LIGHT, HIGH-QUALITY STAINLESS STEEL BASE FRAME. HEAD AND FOOT SECTIONS OF THE LOUNGER CAN BE ADJUSTED TO HORIZONTAL POSITION IN SEVERAL STEPS. THE BACK AND HEADREST OF THE ARMCHAIR WITH RELAX FUNCTION ARE ALSO ADJUSTABLE. LARGE CASTORS ON THE BASE FRAME ENSURE MOBILITY IN THE ROOM. TOGETHER WITH THE NEW STOOL, YOU CAN ENJOY INDIVIDUAL RELAXATION COMFORT. LIGHT, HEIGHT-ADJUSTABLE GLIDES IN THE ARMCHAIR AND STOOL ALLOW LEVELLING ON UNEVEN SURFACES. UNIQUE PIECE PRODUCTION.

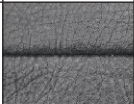
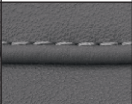

Base frame with castors: Optionally stainless steel square tube with grey castors or black matt fine structure powder-coated metal square tube with black castors.
Intermediate table: metal, matt black fine structure powder-coated.

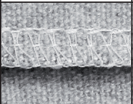
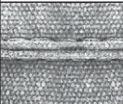
Processing options of main seam / decorative seam					
	Plain seam	Lap seam	KR* (zipper piping) Extra charge	Overcast seam Extra charge	Biese
					
Outdoor fabric	x				x
Outdoor leather	x				x

*Zipper piping: optionally in the colours black, red, nature or light grey.

Outdoor innercover

Additional protection against moisture penetration is provided by an inner cover made of waterproof fabric. The inner cover can be selected for the respective model at an extra charge. Please specify when ordering.

16.01.2023

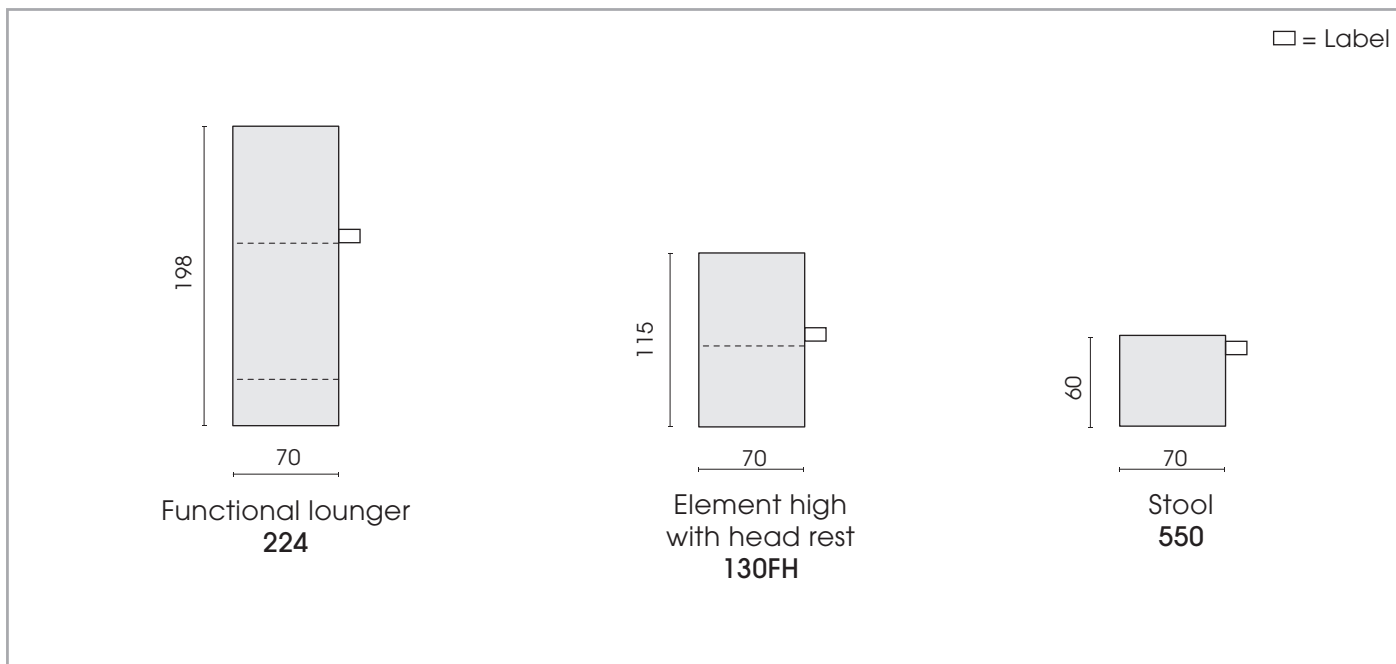
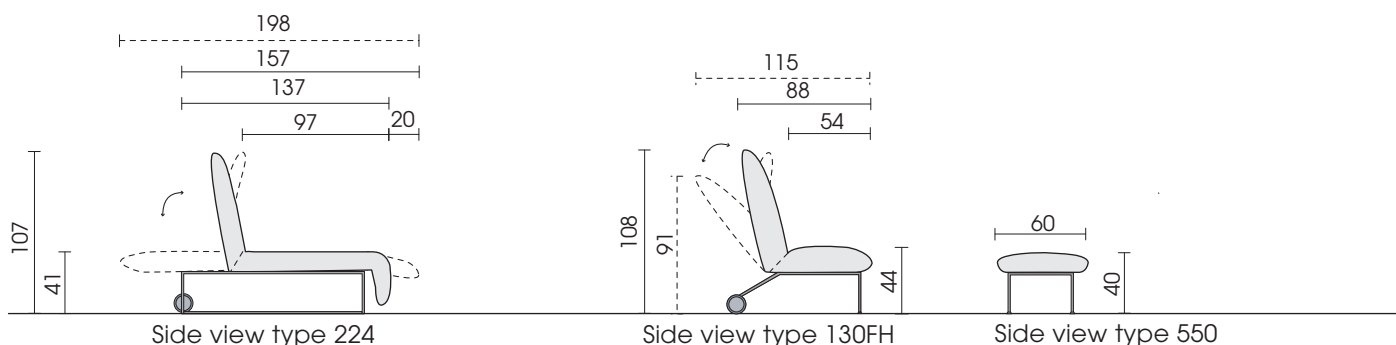

A combination with an intermediate table or a fixation with connector clips is only possible with functional lounger type 224.

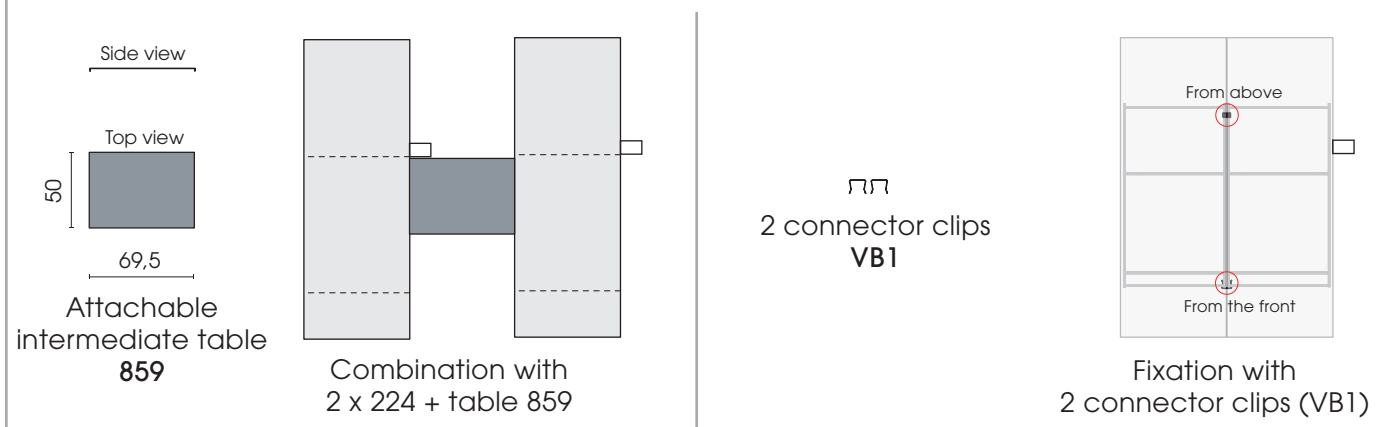

Protective cover (waterproof):

Protective cover for type 224: SH224

Protective cover for type 130FH: SH130FH

Protective cover for type 550: SH550

Each piece of furniture is handmade and unique. Deviations to the listed measurements may be caused by:
 1. different upholstery materials (fabric, leather), 2. processing of ticking mats, 3. the pressure to combine individual parts, etc.
 The seat comfort of a sofa type with larger seat depth usually differs from one with lower depth.