

PRODUCT INFORMATION MODEL 0520 PANDA

© 2020 KURT BEIER & KATI QUINGER



Comfortable headrest



Comfortable rocking function,
lockable via a laterally
mounted hand lever



360° rotation function



Matching stool



Optionally with base plate or...









...cross frame

PANDA: TURNING AND LUFFING CHAIR. COMFORTABLE HEADREST AND COMFORTABLE SEAT WITH THIGH RELIEF. SEAT SHELL, LOCKABLE IN ANY POSITION. OPTIONALLY WITH BASE PLATE OR CROSS FRAME, BLACK. COVERS AVAILABLE IN LEATHER OR FABRIC FROM OUR COLLECTION.

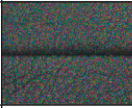

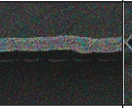
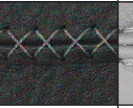
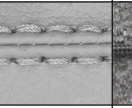

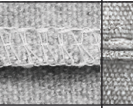
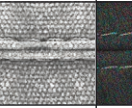
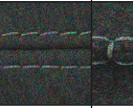

Turning and luffing system, armchair: Optionally with base plate or cross frame; metal, powder-coated fine structure in black matt.
Attention! Maximum load: 110 kg

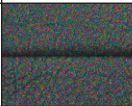

Armchair - Processing options of main seam / decorative seam

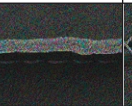
	Plain seam	Lap seam	Raw edged	Moccasin seam extra charge	Twin seam extra charge	KR* (zipper piping) extra charge	Overcast seam extra charge	Piping	Two needle seam	Manufact seam square extra charge
										
Fabric	x	x		x	x	x	x	x		x
Leather***	x	x	x	x	x	x				x
Fake fur	x									

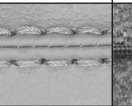
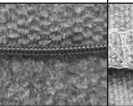
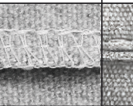
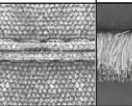
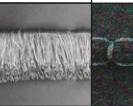
Stool - Processing options of main seam / decorative seam

	Plain seam	Lap seam	Raw edged	Moccasin seam extra charge	Twin seam extra charge	KR* (zipper piping) extra charge	Overcast seam extra charge	Piping	KF** (tassels, piping) extra charge	Manufact seam square extra charge
										
Fabric	x	x		x	x	x	x	x	x	x
Leather	x	x	x	x	x	x				x
Fake fur	x									

It is possible to order main seam or decorative seam either tone in tone like the colours of cover or in the contrasting colours white, nature, grey, rust and black. On request special colours possible.

*Zipper piping: optionally in the colours black, red, nature or light grey.

**Tassels, piping: in colour gold.

***With leather, the dividing seam in the back is always made with a two-needle seam.

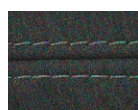

Leather***:
Two needle seam.
Only with dividing
seam in the back

Processing options, cover:

Unicoloured processing:



Two-colour processing:

Attention: Combinations of cover materials are possible analogous to the illustrations in cover groups B1 and B2.

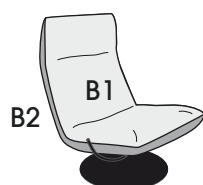

Model 0520 Panda is also available as outdoor product!

For further informations refer to product information OD0520 Panda.

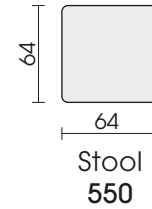
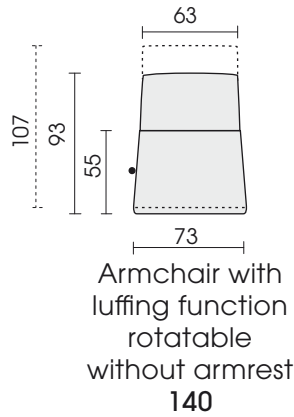
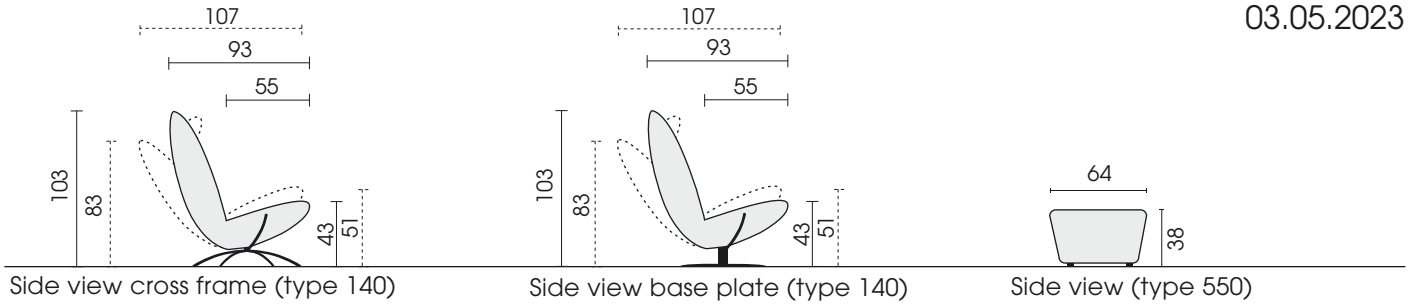

Each piece of furniture is handmade and unique. Deviations to the listed measurements may be caused by:
 1. different upholstery materials (fabric, leather), 2. processing of ticking mats, 3. the pressure to combine individual parts, etc.
 The seat comfort of a sofa type with larger seat depth usually differs from one with lower depth.