

PRODUCT INFORMATION MODEL 0321 SPHINX

© 2021 KURT BEIER & KATI QUINGER



High-quality soft seating comfort



Timeless, cubic design language with modern decorative seams (Handcrafted leather)



Matching stool

SPHINX: SELECT YOUR LOOK

THE LIVING PROGRAMME WITH 3 DIFFERENT VARIANTS. JUST SPHINX! CLEAR CUBIC FORM, THE HIGH-QUALITY COMFORTABLE UPHOLSTERED ELEMENTS AS A BASIS FOR THE DESIRED CONFIGURATION IN THE ROOM. SOFT CUSHIONS FOR COMFORT AND OPTICS COMPLETE THE INDIVIDUAL POSSIBILITIES. UNIQUE PIECE PRODUCTION.

Feet, plastic glides, optionally: 5 cm or 7 cm

THE FINAL DESIGN CAN BE SELECTED IN 3 VARIANTS:

1. **EN VOGUE** - TEXTILE LOOK
2. **CLASSIC** - PURE LEATHER
3. **HANDCRAFTED** - LEATHER WITH MANUFACT SEAMS



EN VOGUE - FABRIC PROCESSING



CLASSIC - LEATHER PROCESSING



HANDCRAFTED - LEATHER PROCESSING WITH MANUFACT SEAMS

FABRIC PROCESSING / LEATHER PROCESSING - CLASSIC

Processing options of main seam / decorative seam

	Plain seam	Lap seam	Raw edged	Moccasin seam extra charge	Twin seam extra charge	KR* (zipper piping) extra charge	Overcast seam extra charge	Piping	Two needle seam	Square seam extra charge
Fabric	x									
Leather**	x									
Fur										

It is possible to order main seam or decorative seam either tone in tone like the colours of cover or in the contrasting colours white, nature, grey, rust and black. On request special colours possible.

*Zipper piping: optionally in the colours black, red, nature or light grey.

**Leather: *Leatherwork - Classic* has dividing seams in seat, back and armrest. - - - -

Attention! Dividing seams in leather are processed with PLAIN SEAM.

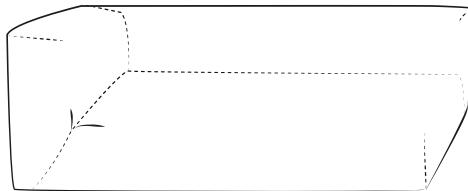

FABRIC PROCESSING
Example: 58t

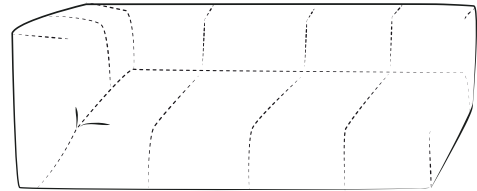

LEATHER PROCESSING - CLASSIC
Example: 58t



FABRIC PROCESSING
Type 22t + type 58t + type 11t



LEATHER PROCESSING - CLASSIC
Type 22t + type 11t

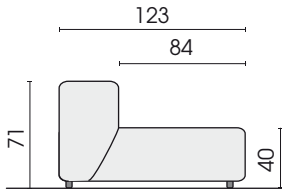

Side view, height with 5 cm feet

▷ = Connector side

□ = Label

Elements

FABRIC / LEATHER - CLASSIC

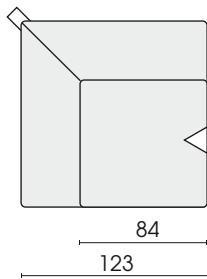

Element, deep left
12t

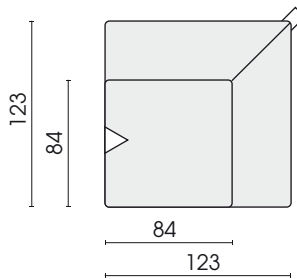

Element, deep right
11t

Only adjustable element, no single element!

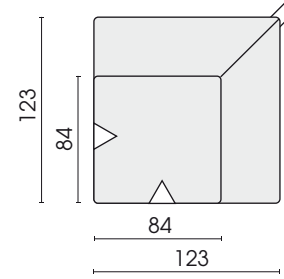

Corner, deep 70t

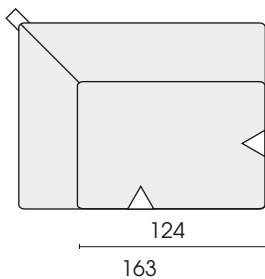

Sofa 2-seat, deep left
22t

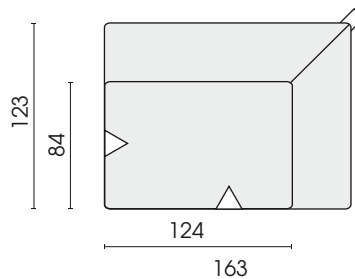

Sofa 2-seat, deep right
21t

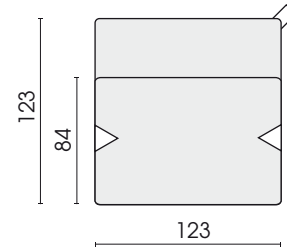

Element, deep 13t

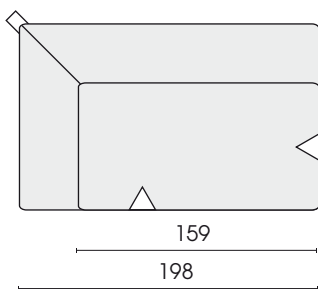

Sofa 2,5-seat, deep left
58t

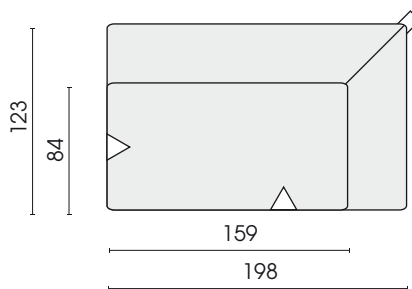

Sofa 2,5-seat, deep right
57t







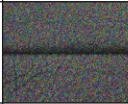
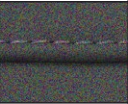
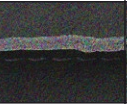

Stool 555

Each piece of furniture is handmade and unique. Deviations to the listed measurements may be caused by:
1. different upholstery materials (fabric, leather), 2. processing of ticking mats, 3. the pressure to combine individual parts, etc.
The seat comfort of a sofa type with larger seat depth usually differs from one with lower depth.

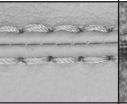
LEATHER PROCESSING - HANDCRAFTED

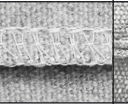
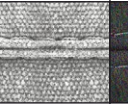
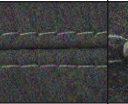
Processing options of main seam / decorative seam

	Plain seam	Lap seam	Raw edged	Moccasin seam	Twin seam	KR* (zipper piping) extra charge	Overcast seam extra charge	Piping	Two needle seam	Square seam
										
Hand-crafted Leather**				x	x					x

It is possible to order main seam or decorative seam either tone in tone like the colours of cover or in the contrasting colours white, nature, grey, rust and black. On request special colours possible.

*Zipper piping: optionally in the colours black, red, nature or light grey.

**Leather: *Leatherwork - Handcrafted*, can be dividing seams in seat and back (plain seam), depending on the type size. - - - - -

**Leather: *Leatherwork - Handcrafted*, the all-round dividing seam is finished with decorative seam. - - - - -

Attention! Dividing seams with Handcrafted workmanship are processed with PLAIN SEAM.

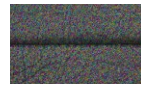

Attention! All-round dividing seams with Handcrafted workmanship are processed with DECORATIVE SEAMS.

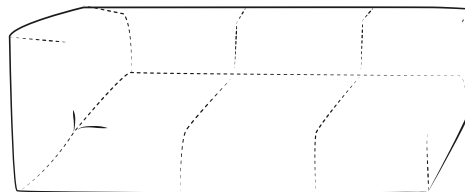
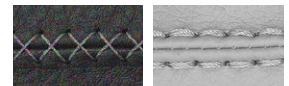

LEATHER PROCESSING - HANDCRAFTED
Example: HC58t



HANDCRAFTED - LEATHER PROCESSING WITH MANUFACT SEAM
Type HC57t + type HC21t

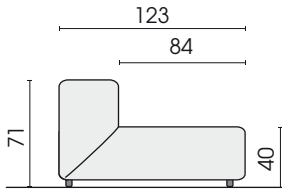

Side view, height with 5 cm feet

▷ = Connector side

□ = Label

Elements

LEATHER - HANDCRAFTED

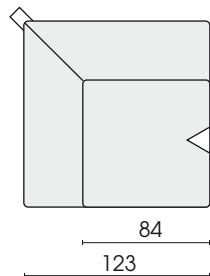

Element, deep left
HC12t

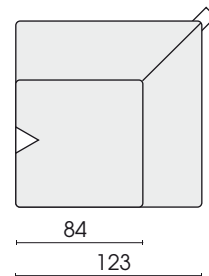

Element, deep right
HC11t

Only adjustable element,
no single element!

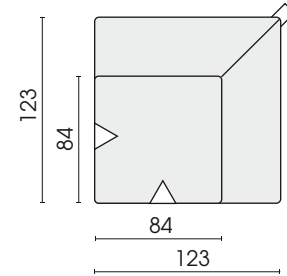

Corner, deep
HC70t

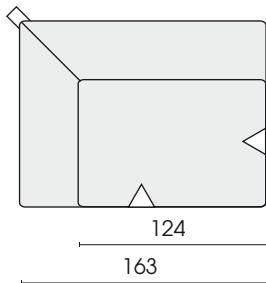

Sofa 2-seat,
deep left
HC22t

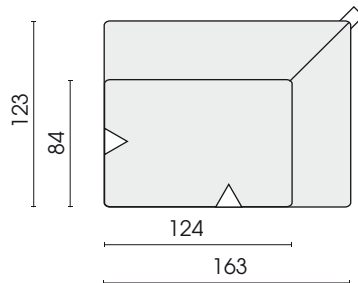

Sofa 2-seat,
deep right
HC21t

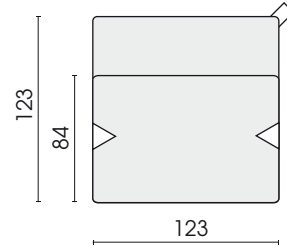

Element, deep
HC13t

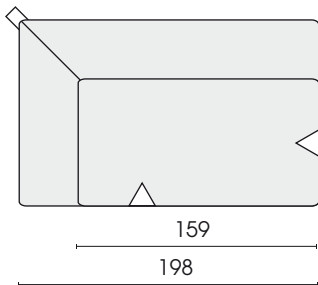

Sofa 2,5-seat,
deep left
HC58t

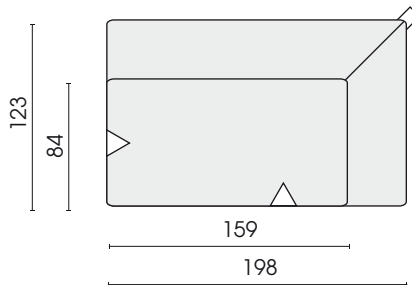

Sofa 2,5-seat,
deep right
HC57t

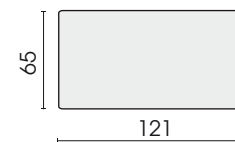

Stool
HC555

Each piece of furniture is handmade and unique. Deviations to the listed measurements may be caused by:
1. different upholstery materials (fabric, leather), 2. processing of ticking mats, 3. the pressure to combine individual parts, etc.
The seat comfort of a sofa type with larger seat depth usually differs from one with lower depth.

Suitable for model Sphinx: Stool type 550 (model 0520 Panda)
 (Fixed seat height with 16 mm plastic glides)

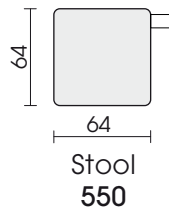
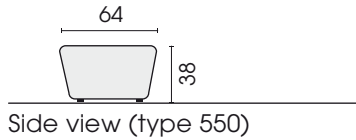

Cushions

Cushions with decorative seams are either tone in tone or contrasting colour possible.

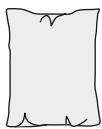

Funkis

Functional cushion
 (tapered cushion)
 (plain seam)
 (Leather: raw edged)
 62 x 78
582



Funkis

Functional cushion
 (with dart)
 (plain seam)
 62 x 78
586



Funkis S

Functional cushion
 (tapered cushion)
 (decorative overcast seam)
 62 x 78
589



Cushion

(tapered cushion)
 (plain seam)
 78 x 58
902



Cushion

(tapered cushion)
 (plain seam)
 72 x 72
904



Cocu

Triangle cushion
 (Fabric: plain seam)
 65 cm
906



Cushion

(tapered cushion)
 (decorative overcast seam)
 60 x 40
925



Cushion

(tapered cushion)
 (decorative overcast seam)
 78 x 60
927



Cushion

(tapered cushion)
 (plain seam)
 78 x 60
949



Cushion

(tapered cushion)
 (plain seam)
 60 x 40
967

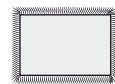

Cushion

(tapered cushion)
 KF (tassels, piping)
 (plain seam)
 60 x 40
967KF



Cushion

(with dart)
 (Fabric: plain seam)
 (Leather: lap seam)
 50 x 50
972



Cushion

(with dart)
 (Fabric: plain seam)
 (Leder: lap seam)
 58 x 58
973

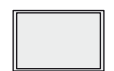

Cushion

(tapered cushion)
 (Fabric: piping)
 (Leather: raw edged)
 60 x 40
975

Each piece of furniture is handmade and unique. Deviations to the listed measurements may be caused by:

1. different upholstery materials (fabric, leather), 2. processing of ticking mats, 3. the pressure to combine individual parts, etc.
- The seat comfort of a sofa type with larger seat depth usually differs from one with lower depth.

Combinations:

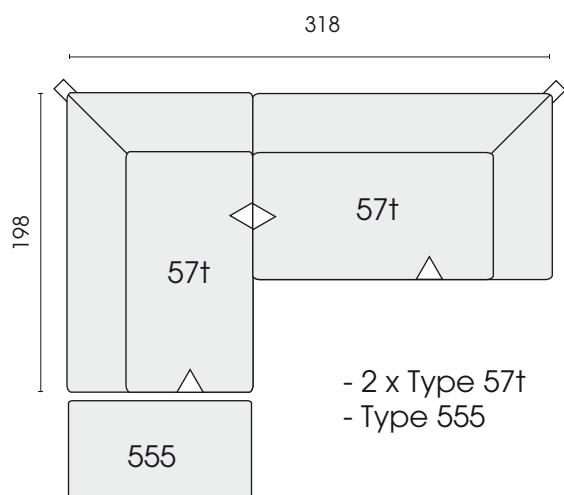
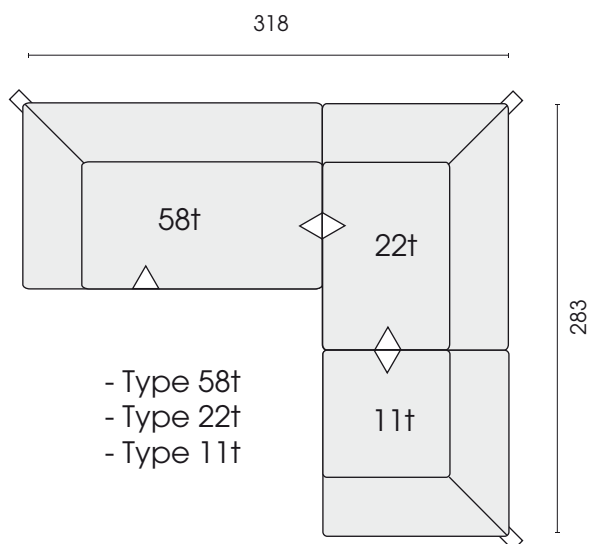

Each piece of furniture is handmade and unique. Deviations to the listed measurements may be caused by:
 1. different upholstery materials (fabric, leather), 2. processing of ticking mats, 3. the pressure to combine individual parts, etc.
 The seat comfort of a sofa type with larger seat depth usually differs from one with lower depth.