

MULTI- DIELE



MULTI-DIELE

Link to the assembly / user instruction movies



Contents

	Page
Range description	2
NEO	4-15
TETRIM	16-27
GENTIS	28-37
Clothes/niche hallway unit	38-51
Switch options for lamps	52-53
Special-sized products, special articles	54-56
Important notes: wall composition / assembly instruction	57

Designed with single units to suit your individual requirements or as a recess solution fitted inch-perfect into the available space, hülsta will welcome you and your guests with a perfect entrance: stylish and confident in terms of design, versatile in terms of functionality and your personal ideas. Whether as a modular combination, recess solution or cabinet system, MULTI-DIELE offers easy access to a coat rack, mirror and all your accessories. It provides a comfortable seat and adds stylish lacquer, natural wood and lighting accents to your entrance. Welcome to your home!



MULTI-DIELE NEO



Lists of versions

Model no.	Carcase, fronts, clothes panels, frames of open compartments	Price group	Model no.	Open compartments (inside), rear walls	Price group	Fabric no.	Seat upholstery
648	Pure white lacquer	I	648	Pure white lacquer	I	S451	Artificial leather with structure white
640	White lacquer	I	640	White lacquer	I	S453	Artificial leather with structure taupe
641	Grey lacquer	I	641	Grey lacquer	I		
663	Silk grey lacquer	I	663	Silk grey lacquer	I		
610	High-gloss pure white lacquer *	II	658	Natural oak	II	S455	Artificial leather with structure brown grey
600	High-gloss white lacquer *	II	680	Core walnut	II		
607	High-gloss grey lacquer *	II					
614	High-gloss silk grey lacquer *	II					
658	Natural oak	II					
680	Core walnut	II					

* The interior carcass of the high-gloss lacquer versions is in a matching matt lacquer colour.

Material identification artificial leather with structure:
top: 100% polyurethane, below: 41% leather, 39% polyethylene, 20% cotton

Important notes

Changing versions:

Colour combinations within individual units are possible. In this case please state the model number clearly and separately in the order! If versions from different price groups are exchanged, the higher price group is always charged.

Standard interior fittings:

Fitted wooden shelves are included behind wooden and mirror doors at 2 Raster intervals.

Drawer frames in standard grey

Wall units:

If units are planned as wall units, a wall bracket must be ordered.

Stacked units:

If units are stacked on top of one another, a wall bracket is only to be ordered for the stacked unit(s) if the stacked unit is wider than the floor unit or if the units are stacked in an off-set position.

Combinations of floor and wall units:

If floor and wall units are combined within an arrangement, there must not be any skirting boards in the room near the floor units, otherwise they must be removed.

Max. load:

Max. load of wooden and glass shelves (up to 70.4 cm width) as well as drawers: 25 kg

Max. load of wooden and glass shelves (between 70.4 and 105.6 cm width): 15 kg

Max. load of wooden and glass shelves (from 105.6 cm width): 10 kg

Max. load of cover shelves: 35 kg per metre length for floor units.

Max. load of units when used as a seat accommodation: 120 kg for floor units.

Please also note any existing maximum load data for individual units which may be stated later and the important notes on the quality of walls at the end of this type list.

hülsta-Push-to-open:

Drawers and flap units with hülsta Push-to-open. All drawers on hidden roller bearings as fully pull-out units.

Wall units / stacked units

If the 2 Raster units are included as wall units, a maximum load per unit of 15 kg per metre must not be exceeded for reasons of stability!

Max. load 15 kg per metre:

52.8 cm width: 7.5 kg

70.4 cm width: 10.0 kg

105.6 cm width: 15.0 kg

140.8 cm width: 20.0 kg

If 4 - 12 Raster units are included as wall units, a maximum load per unit of 40 kg must not be exceeded for reasons of stability!

The wall units can only be fitted on absolutely solid walls. Light masonry is not suitable for this purpose.

For each project please remember to leave a 2.0 cm gap at the top to be able to mount units.

If units are planned as wall units, a wall bracket must be ordered.

If units are stacked on top of one another, a wall bracket is only to be ordered for the stacked unit(s) if the stacked unit is wider than the floor unit or if the units are stacked in an off-set position.

Wall fitting

Important notes: Generally speaking, you as a dealer/qualified fitter are responsible for the correct wall mounting of the units. That is why wall mounting should only be carried out by properly trained and qualified fitters. hülsta supplies materials for mounting units on walls for nearly all the units and which should be used for safety and for constructional reasons. The assembly materials supplied by hülsta (plugs, screws) are only suitable for fitting components on to concrete in firmness class C12/15.

For other materials (please see separate materials table in the wall composition chapter) we provide you with an assembly mortar set as an extra order. Please note that this assembly mortar set is also only suitable for the materials listed in the materials table. If walls are made up of other materials (e.g. plastered or lighter wall materials), one should use another method of mounting better suited to the load on site. Please note that if the units are not mounted properly on the wall, there is a risk of the units falling down or tipping over – especially when alternative mounting materials acquired on site have been used.

For the reasons stated above it is absolutely essential to enquire about the composition of any walls before signing any contracts.

Labelling in type list drawings / assembly notes for wall units

Labelling in type list drawings / assembly notes for wall units

The majority of units have two wall mounting points (= number of base plates), if these are to be fitted as wall units. This is not explicitly mentioned in the type list. If a different number of wall mounting points (= base plates) is required, this is marked in the drawings in the type list with numbers in black boxes. Please be sure to note here the information and notes in the "Wall composition" chapter!

3

4

Notes on delivery

Notes on delivery:

The majority of the units are delivered standard as **fully connected units (glued)** so that the carcass **cannot be disassembled**. There are however some **exceptions** to this rule:

Some carcasses are delivered as complete units but can be **disassembled into individual sections** in the final customer's home. These types are marked with a **1** in the type list.

Some carcasses are delivered **in individual sections** because of their size. These types are marked with a **2** in the type list.

The fronts with the number **2** are delivered separately and can therefore always be (dis-) assembled.

Information on the sketches

Partitions behind flaps

Partitions are used behind flaps in front widths from 140.8 cm. In the sketches the partitions are shown by dotted lines.

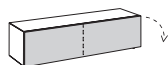

Split drawer frames

Split drawer frames are used for drawers in front widths from 140.8 cm (the partitions are shown by dotted lines in the sketches).

Partitions behind doors

Partitions are used behind doors in front widths from 105.6 cm. In the sketches the partitions are shown by dotted lines.

Order of markings

The markings for the fronts go from left to right and/or from top to bottom.

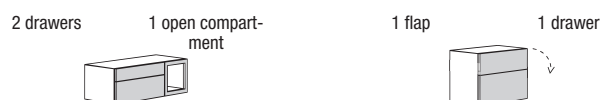

Special combinations

Special combinations are arrangements that are reduced in price. This price advantage is only available when the arrangement is ordered exactly as described. The special combinations can be enhanced by including accessories. These are charged extra.

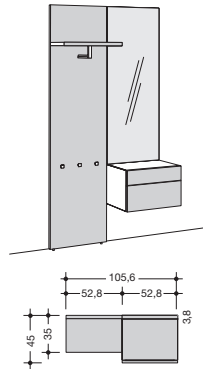

as illustr.
v. versa

995001
995101

Price gr.
I
II

-

-

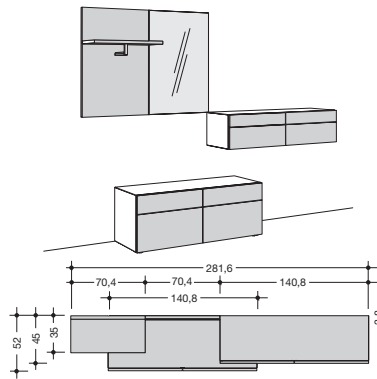

as illustr.
v. versa

995002
995102

Price gr.
I
II

-

-

Suggested combinations

As an alternative to planning an individual unit from the complete range there is the possibility of choosing from specially suggested combinations. This eases planning. Incorporating accessories can enhance the suggested combinations. These are charged extra.

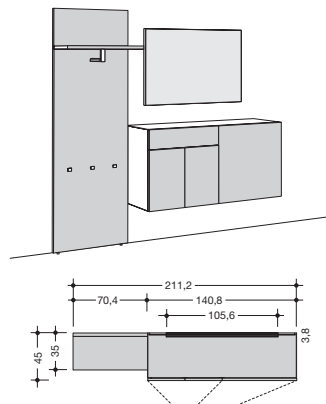

as illustr.
v. versa











985001
985101

Price gr.
I
II

-

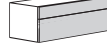
-

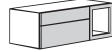

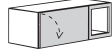
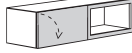

2 Raster units

<p>2 Raster units 35.2 cm high (37,0 cm high incl. 1.8 cm high plinth adjusters), 45.0 cm deep</p>		 52.8 cm wide		 70.4 cm wide		 105.6 cm wide		 140.8 cm wide	
		Flap hinge at bottom	1 drawer	1 flap	1 drawer	1 flap	1 drawer	1 flap	1 drawer
		2451	2452	2471	2472	2411	2412	2441	2442
Price gr.		-	-	-	-	-	-	-	-
I		-	-	-	-	-	-	-	-
II		-	-	-	-	-	-	-	-
		 52.8 cm wide		 70.4 cm wide		 105.6 cm wide		 140.8 cm wide	
		2 drawers		2 drawers		2 drawers		4 drawers	
		2453		2473		2413		2443	
Price gr.		-		-		-		-	
I		-		-		-		-	
II		-		-		-		-	
						 105.6 cm wide		 140.8 cm wide	
						2 drawers; 1 open compartment		2 drawers; 1 open compartment	
<i>as illustr. v. versa</i>						24131 24132		24431 24432	
Price gr.						-		-	
I						-		-	
II						-		-	
						 105.6 cm wide		 140.8 cm wide	
						1 flap; 1 open compartment		1 flap; 1 open compartment	
<i>as illustr. v. versa</i>						24141 24142		24441 24442	
Price gr.						-		-	
I						-		-	
II						-		-	

Wall bracket

<p>If units are to be included as wall units, a wall bracket must be ordered. If units are stacked on top of one another, a wall bracket is only to be ordered for the stacked unit(s) if the stacked unit is wider than the floor unit or if the units are stacked in an off-set position.</p>	for 52.8 cm width	for 70.4 cm width	for 105.6 cm width	for 140.8 cm width
	4528	4704	4105	4140
	-	-	-	-

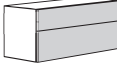
3 and 4 Raster units

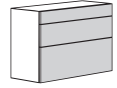

<p>3 Raster units 52.8 cm high (54.6 cm high incl. 1.8 cm high plinth adjusters), 45.0 or 52.0 cm deep</p> <p>52.0 cm deep units cannot be used as wall units!</p>	 52.8 cm wide		 70.4 cm wide		 105.6 cm wide					
	2 drawers		2 drawers		2 drawers					
	45.0 cm deep		52.0 cm deep		45.0 cm deep		52.0 cm deep			
	3451		3551		3471		3571			
	-		-		-		-			
	-		-		-		-			
	Flap hinge at bottom		1 flap; 1 drawer		1 flap; 1 drawer		1 flap; 1 drawer		2 flaps; 2 drawers	
	45.0 cm deep		52.0 cm deep		45.0 cm deep		52.0 cm deep		45.0 cm deep	
	3452		3552		3472		3572		3442	
	-		-		-		-		-	
-		-		-		-		-		
<p>4 Raster units 70.4 cm high (72.2 cm high incl. 1.8 cm high plinth adjusters), 45.0 or 52.0 cm deep</p> <p>52.0 cm deep units cannot be used as wall units!</p>	 52.8 cm wide		 70.4 cm wide		 105.6 cm wide					
	3 drawers		3 drawers		3 drawers					
	45.0 cm deep		52.0 cm deep		45.0 cm deep		52.0 cm deep			
	4451		4551		4471		4571			
	-		-		-		-			
	-		-		-		-			
	as illustr. v. versa		1 door		1 door		2 doors		3 doors; 1 drawer	
	45.0 cm deep		52.0 cm deep		45.0 cm deep		52.0 cm deep		45.0 cm deep	
	44521 L 44522 R		45521 L 45522 R		44721 L 44722 R		45721 L 45722 R		44411 44412	
	-		-		-		-		-	
-		-		-		-		-		

Wall bracket

<p>If units are to be included as wall units, a wall bracket must be ordered. If units are stacked on top of one another, a wall bracket is only to be ordered for the stacked unit(s) if the stacked unit is wider than the floor unit or if the units are stacked in an off-set position.</p>	for 52.8 cm width		for 70.4 cm width		for 105.6 cm width		for 140.8 cm width		
	45.0 cm deep		52.0 cm deep		45.0 cm deep		52.0 cm deep		
	4528		 		4704		 		
-		 		-		 		 	

L/R = Door hinge left/right

5 Raster units

<p>5 Raster units 88.0 cm high (89.8 cm high incl. 1.8 cm high plinth adjusters), 45.0 or 52.0 cm deep</p> <p>52.0 cm deep units cannot be used as wall units!</p>	 52.8 cm wide		 70.4 cm wide		 105.6 cm wide	
	3 drawers		3 drawers		3 drawers	
	45.0 cm deep	52.0 cm deep	45.0 cm deep	52.0 cm deep	45.0 cm deep	52.0 cm deep
	5451	5551	5471	5571	5411	5511
Price gr.						
I	-	-	-	-	-	
II	-	-	-	-	-	

Wall bracket

<p>If units are to be included as wall units, a wall bracket must be ordered. If units are stacked on top of one another, a wall bracket is only to be ordered for the stacked unit(s) if the stacked unit is wider than the floor unit or if the units are stacked in an off-set position.</p>	for 52.8 cm width		for 70.4 cm width		for 105.6 cm width	
	45.0 cm deep	52.0 cm deep	45.0 cm deep	52.0 cm deep	45.0 cm deep	52.0 cm deep
	4528	 	4704	 	4105	
	-		-		-	

6 Raster units

<p>6 Raster units 105.6 cm high (107.4 cm high incl. 1.8 cm high plinth adjusters), 33.0 or 45.0 cm deep</p>								
	1 door		1 door		1 door		2 doors	
	33.0 cm deep	45.0 cm deep	33.0 cm deep	45.0 cm deep	33.0 cm deep	45.0 cm deep	33.0 cm deep	45.0 cm deep
	63311 L 63312 R	64311 L 64312 R	63511 L 63512 R	64511 L 64512 R	63711 L 63712 R	64711 L 64712 R	6311	6411
	Price gr. I	-	-	-	-	-	-	-
	Price gr. II	-	-	-	-	-	-	-
	2 drawers; 1 door		2 drawers; 1 door		2 drawers; 1 door		2 drawers; 2 doors	
	33.0 cm deep	45.0 cm deep	33.0 cm deep	45.0 cm deep	33.0 cm deep	45.0 cm deep	33.0 cm deep	45.0 cm deep
	63321 L 63322 R	64321 L 64322 R	63521 L 63522 R	64521 L 64522 R	63721 L 63722 R	64721 L 64722 R	6312	6412
Price gr. I	-	-	-	-	-	-	-	
Price gr. II	-	-	-	-	-	-	-	
Flap hinge at bottom	3 flaps		3 flaps		3 flaps		3 flaps	
	33.0 cm deep	45.0 cm deep	33.0 cm deep	45.0 cm deep	33.0 cm deep	45.0 cm deep	33.0 cm deep	45.0 cm deep
	6353	6453	6373	6473	6313	6413		
Price gr. I	-	-	-	-	-	-	-	
Price gr. II	-	-	-	-	-	-	-	
3 drawers		3 drawers		3 drawers		3 drawers		
33.0 cm deep	45.0 cm deep	33.0 cm deep	45.0 cm deep	33.0 cm deep	45.0 cm deep	33.0 cm deep	45.0 cm deep	
6354	6454	6374	6474	6314	6414			
Price gr. I	-	-	-	-	-	-	-	
Price gr. II	-	-	-	-	-	-	-	

Wall bracket

<p>If units are to be included as wall units, a wall bracket must be ordered. If units are stacked on top of one another, a wall bracket is only to be ordered for the stacked unit(s) if the stacked unit is wider than the floor unit or if the units are stacked in an off-set position.</p>	for 35.2 cm width	for 52.8 cm width	for 70.4 cm width	for 105.6 cm width
	4352	4528	4704	4105
	-	-	-	-



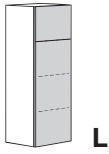
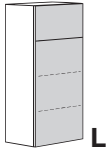
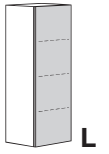
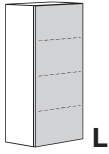
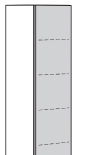
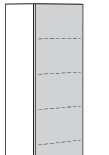
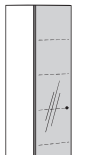
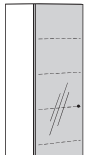





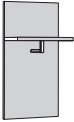
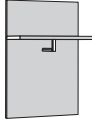

8 and 12 Raster units

<p>8 Raster units 140.8 cm high (142.6 cm high incl. 1.8 cm high plinth adjusters), 45.0 cm deep</p>	 <p>52.8 cm wide</p>		 <p>70.4 cm wide</p>		
	<p>Price gr. I II</p>	<p>1 drawer, 1 door</p> <p>84511 L 84512 R</p> <p>- -</p>		<p>1 drawer, 1 door</p> <p>84711 L 84712 R</p> <p>- -</p>	
		 <p>52.8 cm wide</p>		 <p>70.4 cm wide</p>	
	<p>Price gr. I II</p>	<p>1 door</p> <p>84531 L 84532 R</p> <p>- -</p>		<p>1 door</p> <p>84731 L 84732 R</p> <p>- -</p>	
<p>12 Raster units 211.2 cm high (213.0 cm high incl. 1.8 cm high plinth adjusters), 45.0 cm deep</p> <p>Mirror doors with handle in stainless steel look</p>		 <p>52.8 cm wide</p>		 <p>70.4 cm wide</p>	
	<p>Price gr. I II</p>	<p>1 door</p> <p>124511 L 124512 R</p> <p>- -</p>		<p>1 door</p> <p>124711 L 124712 R</p> <p>- -</p>	
		 <p>52.8 cm wide</p>		 <p>70.4 cm wide</p>	
	<p>Price gr. I II</p>	<p>1 mirror door</p> <p>124521 L 124522 R</p> <p>- -</p>		<p>1 mirror door</p> <p>124721 L 124722 R</p> <p>- -</p>	

Wall bracket

<p>If units are to be included as wall units, a wall bracket must be ordered. If units are stacked on top of one another, a wall bracket is only to be ordered for the stacked unit(s) if the stacked unit is wider than the floor unit or if the units are stacked in an off-set position.</p>	<p>for 52.8 cm width</p>	<p>for 70.4 cm width</p>
	<p>4528</p> <p>-</p>	<p>4704</p> <p>-</p>

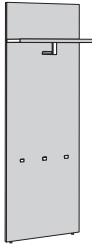
Clothes panels and mirrors

<p>4 Raster clothes panels 70.4 cm high; 3.8 cm thick; 35.0 cm deep incl. hat shelf</p> <p>Clothes rod in high-gloss chrome</p> <p>for fitting anywhere on walls</p>					
		52.8 cm wide	70.4 cm wide		
		incl. hat shelf and clothes rod	incl. hat shelf and clothes rod		
	Price gr.	4951	4971		
	I	-	-		
	II	-	-		
<p>6 Raster clothes panels 105.6 cm high; 3.8 cm thick; 35.0 cm deep incl. hat shelf</p> <p>Clothes rod in high-gloss chrome</p>					
		52.8 cm wide	70.4 cm wide	52.8 cm wide	70.4 cm wide
		incl. hat shelf and clothes rod	incl. hat shelf and clothes rod	Mirror	Mirror
<p>6 Raster mirrors 105.6 cm high; 0.4 cm thick; on 3.2 cm thick grey lac- quered base plate</p> <p>for fitting anywhere on walls</p>		5951	5971	5952	5972
	Price gr.	-	-	-	-
	I	-	-	-	-
	II	-	-	-	-
<p>8 Raster mirrors 140.8 cm high; 0.4 cm thick; on 3.2 cm thick grey lac- quered base plate</p> <p>for fitting anywhere on walls</p>					
				52.8 cm wide	70.4 cm wide
				Mirror	Mirror
			8952	8972	
			-	-	
<p>12 Raster clothes panels 211.2 cm high; 3.8 cm thick; 35.0 cm deep incl. hat shelf</p> <p>Clothes rod and bag hooks in high-gloss chrome</p>					
		52.8 cm wide	70.4 cm wide	52.8 cm wide	
		incl. hat shelf, clothes rod and 3 bag hooks	incl. hat shelf, clothes rod and 3 bag hooks	Mirror	
<p>12 Raster mirrors 211.2 cm high; 0.4 cm thick; on 3.2 cm thick grey lac- quered base plate</p> <p>for fitting anywhere on walls</p>		12951	12971	12952	
	Price gr.	-	-	-	
	I	-	-	-	
	II	-	-	-	

Fitted shelf

Fitted shelf 1.9 cm thick (resp. 2.8 cm thick for 105.6 cm width); for 33.0; 45.0 or 52.0 cm depth													
	for 35.2 cm width			for 52.8 cm width			for 70.4 cm width			for 105.6 cm width			
		for 33.0 cm depth	for 45.0 cm depth	for 52.0 cm depth	for 33.0 cm depth	for 45.0 cm depth	for 52.0 cm depth	for 33.0 cm depth	for 45.0 cm depth	for 52.0 cm depth	for 33.0 cm depth	for 45.0 cm depth	for 52.0 cm depth
		133	134	137	153	154	157	173	174	177	1103	1104	1107
Price gr.													
I	-	-	-	-	-	-	-	-	-	-	-	-	
II	-	-	-	-	-	-	-	-	-	-	-	-	



Shoe rack

Shoe rack 0.2 cm thick; for 33.0; 45.0 or 52.0 cm depth of metal, silver colour anodised Required assembly height: 13.0 cm (for 52.8 cm width) resp. 9.8 cm (for 70.4 cm width)							
	for 52.8 cm width			for 70.4 cm width			
		for 33.0 cm depth	for 45.0 cm depth	for 52.0 cm depth	for 33.0 cm depth	for 45.0 cm depth	for 52.0 cm depth
		1530	1540	1570	1730	1740	1770
	-	-	-	-	-	-	

Seat upholstery

Seat upholstery 5.0 cm high; for 45.0 or 52.0 cm depth Material identification: see range introduction page									
	for 52.8 cm width		for 70.4 cm width		for 105.6 cm width		for 140.8 cm width		
		for 45.0 cm depth	for 52.0 cm depth	for 45.0 cm depth	for 52.0 cm depth	for 45.0 cm depth	for 52.0 cm depth	for 45.0 cm depth	for 52.0 cm depth
		753	553	773	573	7103	5103	7143	5143
	-	-	-	-	-	-	-	-	

Lamps

This luminaire contains built-in LED lamps of the energy classes A++ to A. The lamps cannot be changed in the luminaire. 12 V		LED lamps incl. foot switch. A radio remote control is possible for operation (against a surcharge).			
LED light strip for fitting under wall units 	for 35.2 cm width	for 52.8 cm width	for 70.4 cm width	for 105.6 cm width	for 140.8 cm width
	1.6 W	2.8 W	4.7 W	7.1 W	9.8 W
	535 -	525 -	705 -	105 -	145 -
Integrated LED spotlamp Ø 7.1 cm; for fitting in units Later fitting is not possible. 	2.9 W				
			7941 -		

NEW

Radio remote control with change of colour temperature

The lamps are normally operated by an external foot switch. The colour temperature of the LED lamps is cold white if a foot switch is used. A 4-channel radio remote control is also available as an alternative, which is charged extra. Several lamps can be operated with each of the 4 channels. All 4 channels can be dimmed separately at the push of a button. The colour temperature of all 4 channels can be set to any level from cold white (approx. 6500 kelvin = the basic setting of the LED lamps) to warm white (approx. 2700 kelvin). If warm white is required, a radio remote control must be ordered. It is also possible to switch all channels on and off simultaneously with the "all on" or "all off" buttons. The radio remote control consists of one transmitter and one receiver. If several receivers are required because of the arrangement of the units, these and the corresponding cables are provided ex-works (no surcharge). The foot switch is omitted when the radio remote control is used.



2119
-



MULTI-DIELE TETRIM



Lists of versions

Model no.	Carcase, fronts and clothes panels	Price group	Model no.	Open compartments **: Frame version / inside carcase version	Price group	Fabric no.	Seat upholstery
648	Pure white lacquer	I	940	bronze-colour / satinised glass,	I	S451	Artificial leather with structure white
640	White lacquer	I		rear-lacquered grey-brown		S453	Artificial leather with structure taupe
641	Grey lacquer	I	941	silver-colour / satinised mirror glass	I	S455	Artificial leather with structure brown grey
663	Silk grey lacquer	I					
610	High-gloss pure white lacquer *	II					
600	High-gloss white lacquer *	II					
607	High-gloss grey lacquer *	II					
614	High-gloss silk grey lacquer *	II					
658	Natural oak	II					
680	Core walnut	II					

* The interior carcase of the high-gloss lacquer versions is in a matching matt lacquer colour.

** Open compartments with aluminium frame; frame bronze-colour and interior carcase of satinised glass, rear-lacquered grey-brown or with silver-colour frame and interior carcase of satinised mirror glass. It is not possible to change the colours of the frame and interior carcase.

Material identification artificial leather with structure:
top: 100% polyurethane, below: 41% leather, 39% polyethylene, 20% cotton

Important notes

Open compartments:

Open compartments with aluminium frame; frame bronze-colour and interior carcass of satinised glass, rear-lacquered grey-brown or with silver-colour frame and interior carcass of satinised mirror glass. It is not possible to change the colours of the frame and interior carcass. Please be sure to state the required version when ordering!

Standard interior fittings:

Fitted wooden shelves are included behind doors at 2 Raster intervals.

Drawer frames in standard grey

hülsta-Push-to-open:

Drawers, flaps and hinge-doors with hülsta-Push-to-open device. All drawers on hidden bearings as fully pull-out units.

Max. load:

Max. load of wooden and glass (fitted) shelves (up to 70.4 cm width) and drawers: 25 kg
 Max. load of wooden and glass (fitted) shelves (between 70.4 and 105.6 cm width): 15 kg;
 from 105.6 cm width: 10 kg
 Max. load of cover shelves: 35 kg per metre length for floor units.
 Max. load of units when used as a seat accommodation: 120 kg for floor units.

Please also note any existing maximum load data for individual units which may be stated later and the important notes on the quality of walls at the end of this type list.

Wall units

If the 2 Raster units are included as wall units, a maximum load per unit of 15 kg per metre must not be exceeded for reasons of stability! Max. load 15 kg per metre:

52.8 cm width: 7.5 kg
 70.4 cm width: 10.0 kg
 105.6 cm width: 15.0 kg
 140.8 cm width: 20.0 kg

If 4 - 12 Raster units are included as wall units, a maximum load per unit of 40 kg must not be exceeded for reasons of stability!

The wall units can only be fitted on absolutely solid walls. Light masonry is not suitable for this purpose.

For each project please remember to leave a 2.0 cm gap at the top to be able to mount units.

If units are planned as wall units, a wall bracket must be ordered.

Wall fitting

Important notes: Generally speaking, you as a dealer/qualified fitter are responsible for the correct wall mounting of the units. That is why wall mounting should only be carried out by properly trained and qualified fitters. hülsta supplies materials for mounting units on walls for nearly all the units and which should be used for safety and for constructional reasons. The assembly materials supplied by hülsta (plugs, screws) are only suitable for fitting components on to concrete in firmness class C12/15.

For other materials (please see separate materials table in the wall composition chapter) we provide you with an assembly mortar set as an extra order. Please note that this assembly mortar set is also only suitable for the materials listed in the materials table. If walls are made up of other materials (e.g. plastered or lighter wall materials), one should use another method of mounting better suited to the load on site. Please note that if the units are not mounted properly on the wall, there is a risk of the units falling down or tipping over – especially when alternative mounting materials acquired on site have been used.

For the reasons stated above it is absolutely essential to enquire about the composition of any walls before signing any contracts.

Labelling in type list drawings / assembly notes for wall units

Labelling in type list drawings / assembly notes for wall units

The majority of units have two wall mounting points (= number of base plates), if these are to be fitted as wall units. This is not explicitly mentioned in the type list. If a different number of wall mounting points (= base plates) is required, this is marked in the drawings in the type list with numbers in black boxes. Please be sure to note here the information and notes in the "Wall composition" chapter!

3

4

Notes on delivery

Notes on delivery:

The majority of the units are delivered standard as **fully connected units (glued)** so that the carcass **cannot be disassembled**. There are however some **exceptions** to this rule:

Some carcasses are delivered as complete units but can be **disassembled into individual sections** in the final customer's home. These types are marked with a **1** in the type list.

Some carcasses are delivered **in individual sections** because of their size. These types are marked with a **2** in the type list.

The fronts with the number **2** are delivered separately and can therefore always be (dis-) assembled.

Information on the sketches

Split drawer frames:

Split drawer frames are used for drawers in front widths of 140.8 cm (the partitions are shown by dotted lines in the sketches).

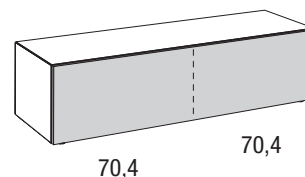

Special combinations

Special combinations are arrangements that are reduced in price. This price advantage is only available when the arrangement is ordered exactly as described. The special combinations can be enhanced by including accessories. These are charged extra.

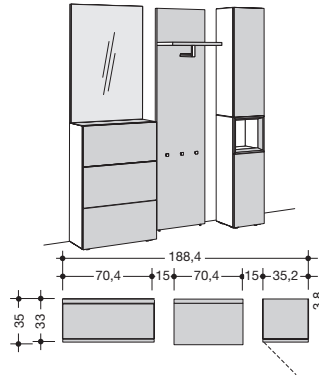

as illustr.
v. versa

995003
995103

Price gr.

I
II

-
-

Suggested combinations

As an alternative to planning an individual unit from the complete range there is the possibility of choosing from specially suggested combinations. This eases planning. Incorporating accessories can enhance the suggested combinations. These are charged extra.

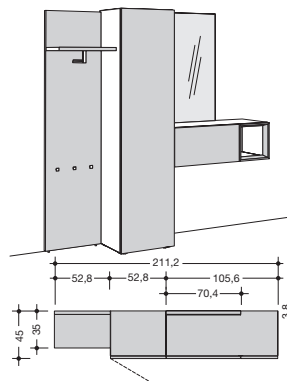

as illustr.
v. versa

985002
985102

Price gr.

I
II

-
-

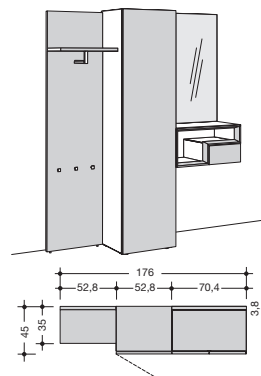

as illustr.
v. versa









985003
985103

Price gr.

I
II

-
-

2 Raster units

<p>2 Raster units 35.2 cm high (37,0 cm high incl. 1.8 cm high plinth adjusters), 45.0 cm deep</p>	 52.8 cm wide		 70.4 cm wide		 105.6 cm wide		 140.8 cm wide		
	Flap hinge at bottom	1 drawer	1 flap	1 drawer	1 flap	1 drawer	1 flap	1 drawer	1 flap
		2451	2452	2471	2472	2411	2412	2441	2442
	Price gr.	I	-	-	-	-	-	-	-
		II	-	-	-	-	-	-	-
			 70.4 cm wide		 105.6 cm wide		 140.8 cm wide		
	Flap hinge at bottom			1 open compartment; 1 drawer		1 flap; 1 open compartment		1 flap; 1 open compartment	
		as illustr. v. versa		24741 24742		24151 24152		24451 24452	
	Price gr.			-		-		-	
				-		-		-	
		 70.4 cm wide							
Price gr.			1 open compartment						
			2475						
				-					
				-					

Wall bracket

<p>If units are to be included as wall units, a wall bracket must be ordered. If units are stacked on top of one another, a wall bracket is only to be ordered for the stacked unit(s) if the stacked unit is wider than the floor unit or if the units are stacked in an off-set position.</p>	for 52.8 cm width	for 70.4 cm width	for 105.6 cm width	for 140.8 cm width
	4528	4704	4105	4140
	-	-	-	-

3 and 4 Raster units



<p>3 Raster units 52.8 cm high (54.6 cm high incl. 1.8 cm high plinth adjusters), 45.0 or 52.0 cm deep</p> <p>52.0 cm deep units cannot be used as wall units!</p>									
	52.8 cm wide		70.4 cm wide		105.6 cm wide		140.8 cm wide		
	2 drawers		2 drawers		2 drawers		2 drawers; 1 open compartment		
	45.0 cm deep		52.0 cm deep		45.0 cm deep		52.0 cm deep		
	as illustr. v. versa		3451		3551		34411 34412		
	Price gr. I		-		-		-		
	Price gr. II		-		-		-		
	52.8 cm wide		70.4 cm wide		105.6 cm wide		140.8 cm wide		
	Flap hinge at bottom		1 flap; 1 drawer		1 flap; 1 drawer		1 flap; 1 drawer		2 flaps; 2 drawers
45.0 cm deep		52.0 cm deep		45.0 cm deep		52.0 cm deep		45.0 cm deep	
52.0 cm deep		52.0 cm deep		45.0 cm deep		52.0 cm deep		45.0 cm deep	
Price gr. I		-		-		-		-	
Price gr. II		-		-		-		-	
<p>4 Raster units 70.4 cm high (72.2 cm high incl. 1.8 cm high plinth adjusters), 45.0 or 52.0 cm deep</p> <p>52.0 cm deep units cannot be used as wall units!</p>									
	52.8 cm wide		70.4 cm wide		105.6 cm wide				
	3 drawers		3 drawers		3 drawers				
	45.0 cm deep		52.0 cm deep		45.0 cm deep		52.0 cm deep		
	Price gr. I		4451		4551		4471		
	Price gr. II		-		-		-		
	45.0 cm deep		52.0 cm deep		45.0 cm deep		52.0 cm deep		
	Price gr. I		-		-		-		
	Price gr. II		-		-		-		
52.8 cm wide		70.4 cm wide		105.6 cm wide		140.8 cm wide			
1 door		1 door		2 doors		3 doors; 1 drawer			
45.0 cm deep		52.0 cm deep		45.0 cm deep		52.0 cm deep			
as illustr. v. versa		44521 L 44522 R		44721 L 44722 R		45721 L 45722 R			
Price gr. I		-		-		-			
Price gr. II		-		-		-			
45.0 cm deep		52.0 cm deep		45.0 cm deep		52.0 cm deep			
Price gr. I		44411 44412		44412		44411 44412			
Price gr. II		-		-		-			

Wall bracket

<p>If units are to be included as wall units, a wall bracket must be ordered. If units are stacked on top of one another, a wall bracket is only to be ordered for the stacked unit(s) if the stacked unit is wider than the floor unit or if the units are stacked in an off-set position.</p>	for 52.8 cm width		for 70.4 cm width		for 105.6 cm width		for 140.8 cm width	
	45.0 cm deep		52.0 cm deep		45.0 cm deep		52.0 cm deep	
	4528				4704			
-				-				
45.0 cm deep		52.0 cm deep		45.0 cm deep		52.0 cm deep		
Price gr. I		-		-		-		
Price gr. II		-		-		-		

L/R = Door hinge left/right

5 Raster units

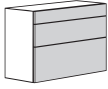
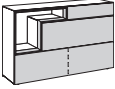
<p>5 Raster units 88.0 cm high (89.8 cm high incl. 1.8 cm high plinth adjusters), 45.0 or 52.0 cm deep</p> <p>52.0 cm deep units cannot be used as wall units!</p>	 52.8 cm wide		 70.4 cm wide		 105.6 cm wide		 140.8 cm wide	
	3 drawers		3 drawers		3 drawers		3 drawers; 1 open compartment	
	45.0 cm deep		52.0 cm deep		45.0 cm deep		52.0 cm deep	
	5451		5551		5471		5571	
	5411		5511		54411 54412		X	
<p>as illustr. v. versa</p> <p>Price gr. I II</p>	-		-		-		-	
	-		-		-		-	

Wall bracket

<p>If units are to be included as wall units, a wall bracket must be ordered. If units are stacked on top of one ano- ther, a wall bracket is only to be ordered for the stacked unit(s) if the stacked unit is wider than the floor unit or if the units are stacked in an off-set position.</p>	for 52.8 cm width		for 70.4 cm width		for 105.6 cm width		for 140.8 cm width	
	45.0 cm deep		52.0 cm deep		45.0 cm deep		52.0 cm deep	
	4528		X		4704		X	
	-		-		-		-	
	-		-		-		-	

6 Raster units

<p>6 Raster units 105.6 cm high (107.4 cm high incl. 1.8 cm high plinth adjusters), 33.0 or 45.0 cm deep</p>									
	1 door		1 door		1 door		2 doors		
	33.0 cm deep		45.0 cm deep		33.0 cm deep		45.0 cm deep		
	63311 L 63312 R		64311 L 64312 R		63511 L 63512 R		64511 L 64512 R		
	63711 L 63712 R		64711 L 64712 R		6311		6411		
	Price gr.	-		-		-		-	
		-		-		-		-	
	2 drawers; 1 door		2 drawers; 1 door		2 drawers; 1 door		2 drawers; 2 doors		
	33.0 cm deep		45.0 cm deep		33.0 cm deep		45.0 cm deep		
	63321 L 63322 R		64321 L 64322 R		63521 L 63522 R		64521 L 64522 R		
	63721 L 63722 R		64721 L 64722 R		6312		6412		
	Price gr.	-		-		-		-	
		-		-		-		-	
	Flap hinge at bottom	1 door; 1 open compartment		3 flaps		3 flaps		3 flaps	
		33.0 cm deep		45.0 cm deep		33.0 cm deep		45.0 cm deep	
	63331 L 63332 R		64331 L 64332 R		6353		6453		
	6373		6473		6313		6413		
	Price gr.	-		-		-		-	
		-		-		-		-	
	1 door; 1 open compartment		3 drawers		3 drawers		3 drawers		
	33.0 cm deep		45.0 cm deep		33.0 cm deep		45.0 cm deep		
63341 L 63342 R		64341 L 64342 R		6354		6454			
6374		6474		6314		6414			
Price gr.	-		-		-		-		
	-		-		-		-		

Wall bracket

<p>If units are to be included as wall units, a wall bracket must be ordered. If units are stacked on top of one another, a wall bracket is only to be ordered for the stacked unit(s) if the stacked unit is wider than the floor unit or if the units are stacked in an off-set position.</p>	for 35.2 cm width	for 52.8 cm width	for 70.4 cm width	for 105.6 cm width
	4352	4528	4704	4105
	-	-	-	-



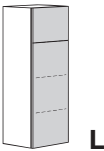
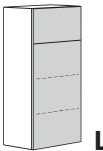
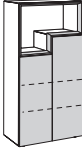
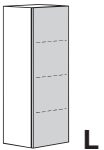
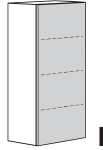
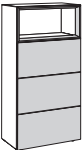
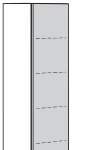
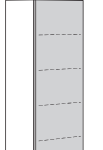
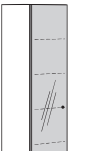
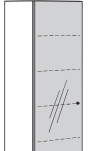





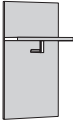
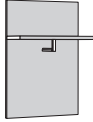

8 and 12 Raster units

<p>8 Raster units 140.8 cm high (142.6 cm high incl. 1.8 cm high plinth adjusters), 45.0 cm deep</p>				
		52.8 cm wide	70.4 cm wide	70.4 cm wide
	as illustr. v. versa	1 drawer, 1 door	1 drawer, 1 door	1 open compartment; 2 doors
		84511 L 84512 R	84711 L 84712 R	84721 84722
	Price gr.	-	-	-
	I	-	-	-
<p>12 Raster units 211.2 cm high (213.0 cm high incl. 1.8 cm high plinth adjusters), 45.0 cm deep</p> <p>Mirror doors with handle in stainless steel look</p>				
		52.8 cm wide	70.4 cm wide	70.4 cm wide
		1 door	1 door	1 open compartment; 3 drawers
		84531 L 84532 R	84731 L 84732 R	8474
	Price gr.	-	-	-
	I	-	-	-
<p>12 Raster units 211.2 cm high (213.0 cm high incl. 1.8 cm high plinth adjusters), 45.0 cm deep</p> <p>Mirror doors with handle in stainless steel look</p>				
		52.8 cm wide	70.4 cm wide	
		1 door	1 door	
		124511 L 124512 R	124711 L 124712 R	
	Price gr.	-	-	
	I	-	-	
<p>12 Raster units 211.2 cm high (213.0 cm high incl. 1.8 cm high plinth adjusters), 45.0 cm deep</p> <p>Mirror doors with handle in stainless steel look</p>				
		52.8 cm wide	70.4 cm wide	
		1 mirror door	1 mirror door	
		124521 L 124522 R	124721 L 124722 R	
	Price gr.	-	-	
	I	-	-	

Wall bracket

<p>If units are to be included as wall units, a wall bracket must be ordered. If units are stacked on top of one another, a wall bracket is only to be ordered for the stacked unit(s) if the stacked unit is wider than the floor unit or if the units are stacked in an off-set position.</p>	for 52.8 cm width	for 70.4 cm width	for 70.4 cm width
	4528	4704	4704
	-	-	-

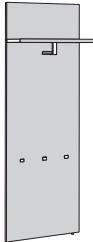
Clothes panels and mirrors

<p>4 Raster clothes panels 70.4 cm high; 3.8 cm thick; 35.0 cm deep incl. hat shelf</p> <p>Clothes rod in high-gloss chrome</p> <p>for fitting anywhere on walls</p>				
	52.8 cm wide	70.4 cm wide		
	incl. hat shelf and clothes rod	incl. hat shelf and clothes rod		
Price gr.	4951	4971		
	-	-		
	-	-		
<p>6 Raster clothes panels 105.6 cm high; 3.8 cm thick; 35.0 cm deep incl. hat shelf</p> <p>Clothes rod in high-gloss chrome</p> <p>6 Raster mirrors 105.6 cm high; 0.4 cm thick; on 3.2 cm thick grey lac- quered base plate</p> <p>for fitting anywhere on walls</p>				
	52.8 cm wide	70.4 cm wide	52.8 cm wide	70.4 cm wide
	incl. hat shelf and clothes rod	incl. hat shelf and clothes rod	Mirror	Mirror
Price gr.	5951	5971	5952	5972
	-	-	-	-
	-	-	-	-
<p>8 Raster mirrors 140.8 cm high; 0.4 cm thick; on 3.2 cm thick grey lac- quered base plate</p> <p>for fitting anywhere on walls</p>				
			52.8 cm wide	70.4 cm wide
			Mirror	Mirror
Price gr.			8952	8972
			-	-
			-	-
<p>12 Raster clothes panels 211.2 cm high; 3.8 cm thick; 35.0 cm deep incl. hat shelf</p> <p>Clothes rod and bag hooks in high-gloss chrome</p> <p>12 Raster mirrors 211.2 cm high; 0.4 cm thick; on 3.2 cm thick grey lac- quered base plate</p> <p>for fitting anywhere on walls</p>				
	52.8 cm wide	70.4 cm wide	52.8 cm wide	
	incl. hat shelf, clothes rod and 3 bag hooks	incl. hat shelf, clothes rod and 3 bag hooks	Mirror	
Price gr.	12951	12971	12952	
	-	-	-	
	-	-	-	

Fitted shelf

<p>Fitted shelf 1.9 cm thick (resp. 2.8 cm thick for 105.6 cm width); for 33.0; 45.0 or 52.0 cm depth</p> 	for 35.2 cm width			for 52.8 cm width			for 70.4 cm width			for 105.6 cm width		
	for 33.0 cm depth	for 45.0 cm depth	for 52.0 cm depth	for 33.0 cm depth	for 45.0 cm depth	for 52.0 cm depth	for 33.0 cm depth	for 45.0 cm depth	for 52.0 cm depth	for 33.0 cm depth	for 45.0 cm depth	for 52.0 cm depth
	133	134	137	153	154	157	173	174	177	1103	1104	1107
	Price gr.											
I	-	-	-	-	-	-	-	-	-	-	-	-
II	-	-	-	-	-	-	-	-	-	-	-	-







Shoe rack

<p>Shoe rack 0.2 cm thick; for 33.0; 45.0 or 52.0 cm depth</p> <p>of metal, silver colour anodised</p> <p>Required assembly height: 13.0 cm (for 52.8 cm width) resp. 9.8 cm (for 70.4 cm width)</p> 	for 52.8 cm width			for 70.4 cm width		
	for 33.0 cm depth	for 45.0 cm depth	for 52.0 cm depth	for 33.0 cm depth	for 45.0 cm depth	for 52.0 cm depth
	1530	1540	1570	1730	1740	1770
	-	-	-	-	-	-

Seat upholstery

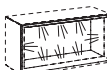
<p>Seat upholstery 5.0 cm high; for 45.0 or 52.0 cm depth</p> <p>Material identification: see range introduction page</p> 	for 52.8 cm width		for 70.4 cm width		for 105.6 cm width		for 140.8 cm width	
	for 45.0 cm depth	for 52.0 cm depth	for 45.0 cm depth	for 52.0 cm depth	for 45.0 cm depth	for 52.0 cm depth	for 45.0 cm depth	for 52.0 cm depth
	753	553	773	573	7103	5103	7143	5143
	-	-	-	-	-	-	-	-

Lamps

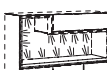
This luminaire contains built-in LED lamps of the energy classes A++ to A. The lamps cannot be changed in the luminaire. 12 V		LED lamps incl. foot switch. A radio remote control is possible for operation (against a surcharge).			
LED light strip for fitting under wall units 	for 35.2 cm width	for 52.8 cm width	for 70.4 cm width	for 105.6 cm width	for 140.8 cm width
	1.6 W	2.8 W	4.7 W	7.1 W	9.8 W
	535	525	705	105	145
	-	-	-	-	-
Integrated LED spotlamp Ø 7.1 cm; for fitting in units Later fitting is not possible. 	2.9 W				
	7941				-
LED frame lamps for fitting in frame of open compartments	Frame form:  9.0 W Frame form:  14.5 W 540 -	Frame form:  14.5 W Frame form:  17.2 W Frame form:  17.2 W Frame form:  22.7 W 550 -			

NEW

Radio remote control with change of colour temperature

The lamps are normally operated by an external foot switch. The colour temperature of the LED lamps is cold white if a foot switch is used. A 4-channel radio remote control is also available as an alternative, which is charged extra. Several lamps can be operated with each of the 4 channels. All 4 channels can be dimmed separately at the push of a button. The colour temperature of all 4 channels can be set to any level from cold white (approx. 6500 kelvin = the basic setting of the LED lamps) to warm white (approx. 2700 kelvin). If warm white is required, a radio remote control must be ordered. It is also possible to switch all channels on and off simultaneously with the "all on" or "all off" buttons. The radio remote control consists of one transmitter and one receiver. If several receivers are required because of the arrangement of the units, these and the corresponding cables are provided ex-works (no surcharge). The foot switch is omitted when the radio remote control is used.



2119

-



MULTI-DIELE GENTIS



Lists of versions

Model no.	Carcase, fronts	Price group	Model no.	Accent units: Carcase, fronts and clothes panels	Price group	Fabric no.	Seat upholstery
648	Pure white lacquer	I	648	Pure white lacquer	I	S451	Artificial leather with structure white
640	White lacquer	I	640	White lacquer	I	S453	Artificial leather with structure taupe
641	Grey lacquer	I	641	Grey lacquer	I		
663	Silk grey lacquer	I	663	Silk grey lacquer	I	S455	Artificial leather with structure brown grey
610	High-gloss pure white lacquer *	II	610	High-gloss pure white lacquer *	II		
600	High-gloss white lacquer *	II	600	High-gloss white lacquer *	II		
607	High-gloss grey lacquer *	II	607	High-gloss grey lacquer *	II		
614	High-gloss silk grey lacquer *	II	614	High-gloss silk grey lacquer *	II		
			658	Natural oak	II		
			680	Core walnut	II		
			693	Knotted oak	III		
			697	Knotted oak anthracite	III		
			694	Knotted core walnut	III		

* The interior carcass of the versions pure white lacquer, white lacquer, high-gloss pure white lacquer and high-gloss white lacquer is in a matt white lacquer version. The same applies to the straight outer side of the units with rounded end at one side. The interior carcass of the versions grey lacquer, silk grey lacquer, high-gloss grey lacquer and high-gloss silk grey lacquer is in a matt grey lacquer version. The same applies to the straight outer side of the units with rounded end at one side.

Material identification artificial leather with structure:
top: 100% polyurethane, below: 41% leather, 39% polyethylene, 20% cotton

Important notes

Glass versions:

Outer glass sides of 8 Raster units with accent rear wall of bronzed glass.

Accent units, accent rear wall:

Carcase and front as well as accent rear wall also in the versions knotted oak, knotted oak anthracite and knotted core walnut possible.

Interior carcass:

The interior carcass of the versions pure white lacquer, white lacquer, high-gloss pure white lacquer and high-gloss white lacquer is in a matt white lacquer version. The same applies to the straight outer side of the units with rounded end at one side. The interior carcass of the versions grey lacquer, silk grey lacquer, high-gloss grey lacquer and high-gloss silk grey lacquer is in a matt grey lacquer version. The same applies to the straight outer side of the units with rounded end at one side.

Standard interior fittings:

Fitted wooden shelves are included behind doors at 2 Raster intervals.

Functional frame:

Functional frame always in white lacquer.

Wall units:

If units are planned as wall units, a wall bracket must be ordered.

Drawer frames in grey

Combinations of floor and wall units:

If floor and wall units are combined within an arrangement, there must not be any skirting boards in the room near the floor units, otherwise they must be removed.

Max. load:

Max. load of wooden and glass shelves (up to 70.4 cm width) as well as drawers: 25 kg

Max. load of wooden and glass shelves (between 70.4 and 105.6 cm width): 15 kg;

from 105.6 cm width: 10 kg

Max. load of cover shelves: 35 kg per metre length for floor units.

Max. load of units when used as a seat accommodation: 120 kg for floor units.

Please also note any maximum loads which may be stated in the type list for the individual units!

hülsta-Push-to-open:

Drawers and flap units with hülsta Push-to-open. All drawers on hidden roller bearings as fully pull-out units.

Labelling in type list drawings / assembly notes for wall units

Labelling in type list drawings / assembly notes for wall units

The majority of units have two wall mounting points (= number of base plates), if these are to be fitted as wall units. This is not explicitly mentioned in the type list. If a different number of wall mounting points (= base plates) is required, this is marked in the drawings in the type list with numbers in black boxes. Please be sure to note here the information and notes in the "Wall composition" chapter!

3
4

Notes on delivery

Notes on delivery:

The majority of the units are delivered standard as **fully connected units (glued)** so that the carcass **cannot be disassembled**. There are however some **exceptions** to this rule:

Some carcasses are delivered as complete units but can be **disassembled into individual sections** in the final customer's home. These types are marked with a **1** in the type list.

1

Some carcasses are delivered **in individual sections** because of their size. These types are marked with a **2** in the type list.

2

The fronts with the number **2** are delivered separately and can therefore always be (dis-) assembled.

Wall fitting

Important notes: Generally speaking, you as a dealer/qualified fitter are responsible for the correct wall mounting of the units. That is why wall mounting should only be carried out by properly trained and qualified fitters. hülsta supplies materials for mounting units on walls for nearly all the units and which should be used for safety and for constructional reasons. The assembly materials supplied by hülsta (plugs, screws) are only suitable for fitting components on to concrete in firmness class C12/15.

For other materials (please see separate materials table in the wall composition chapter) we provide you with an assembly mortar set as an extra order. Please note that this assembly mortar set is also only suitable for the materials listed in the materials table. If walls are made up of other materials (e.g. plastered or lighter wall materials), one should use another method of mounting better suited to the load on site. Please note that if the units are not mounted properly on the wall, there is a risk of the units falling down or tipping over – especially when alternative mounting materials acquired on site have been used. For the reasons stated above it is absolutely essential to enquire about the composition of any walls before signing any contracts.

Suggested combinations

As an alternative to planning an individual unit from the complete range there is the possibility of choosing from specially suggested combinations. This eases planning. Incorporating accessories can enhance the suggested combinations. These are charged extra.

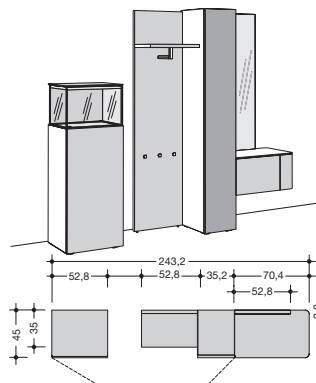







985004
985104

as illustr.
v. versa



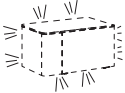
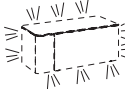
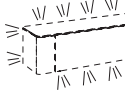

Price gr.
I
II
III

-
-
-

2 Raster units with rounded end at one side

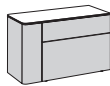
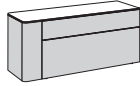
<p>2 Raster units with rounded end at one side 36.2 cm high (38.0 cm high incl. 1.8 cm high plinth adjusters), 45.0 cm deep</p>	<p style="text-align: center;">2 Raster units with rounded end at one side</p>						
	 <p style="text-align: center;">52,8</p> <p style="text-align: center;">70.4 cm wide</p>		 <p style="text-align: center;">70,4</p> <p style="text-align: center;">88.0 cm wide</p>		 <p style="text-align: center;">105,6</p> <p style="text-align: center;">123.2 cm wide</p>		
	Flap hinge at bottom	1 drawer	1 flap	1 drawer	1 flap	1 drawer	1 flap
	as illustr. v. versa	24761 24762	24771 24772	24811 24812	24821 24822	24211 24212	24221 24222
Price gr. I II	-	-	-	-	-	-	
NEW Drawer for end unit left (L; as illustr.) or right (R; vice versa)	291L	292R	291L	292R	291L	292R	
NEW Hinge-door for end unit left (L; as illustr.) or right (R; vice versa)	281L	282R	281L	282R	281L	282R	
Wall bracket If units are planned as wall units, a wall bracket must be ordered. Max. load: 40 kg	255		275		2105		
Functional frame for floor units The units can be planned optionally with a functional frame for floor units. Functional frame for wall assembly If you plan a functional frame for wall assembly, you require an extra wall bracket. In this case the plinth adjusters are omitted. Max. load: 40 kg							
	Functional frame for floor units	Functional frame for wall assembly	Functional frame for floor units	Functional frame for wall assembly	Functional frame for floor units	Functional frame for wall assembly	
	252	253	272	273	2102	2103	
	-	-	-	-	-	-	
Lamp for functional frame The functional frame can be fitted with an optional LED lamp. LED lamp incl. footswitch. Lamp switch optionally with a remote control unit (against surcharge). Later fitting is not possible. This luminaire contains built-in LED lamps of the energy classes A++ to A. The lamps cannot be changed in the luminaire. 12 V	8.0 W	12.0 W	9.5 W	15.5 W	12.5 W	21.0 W	
							
	254		274		2104		
	-		-		-		

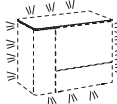
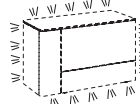
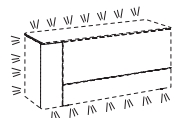

3 Raster units with rounded end at one side

<p>3 Raster units with rounded end at one side 53.8 cm high (55.6 cm high incl. 1.8 cm high plinth adjusters), 45.0 cm deep</p>	<p>3 Raster units with rounded end at one side</p>						
	 <p>52,8</p> <p>70.4 cm wide</p>		 <p>70,4</p> <p>88.0 cm wide</p>		 <p>105,6</p> <p>123.2 cm wide</p>		
	Flap hinge at bottom	2 drawers	<p>Top: 1 drawer Bottom: 1 flap</p>	2 drawers	<p>Top: 1 drawer Bottom: 1 flap</p>	2 drawers	<p>Top: 1 drawer Bottom: 1 flap</p>
	as illustr. v. versa	<p>34761 34762</p>	<p>34771 34772</p>	<p>34811 34812</p>	<p>34821 34822</p>	<p>34211 34212</p>	<p>34221 34222</p>
Price gr. I II	- -	- -	- -	- -	- -	- -	
<p>Drawer for end unit left (L; as illustr.) or right (R; vice versa)</p>	391L	392R	391L	392R	391L	392R	
<p>Hinge-door for end unit left (L; as illustr.) or right (R; vice versa)</p>	381L	382R	381L	382R	381L	382R	
<p>Wall bracket If units are planned as wall units, a wall bracket must be ordered. Max. load: 40 kg</p>	255	-	275	-	2105	-	
<p>Functional frame for floor units The units can be planned optionally with a functional frame for floor units.</p> <p>Functional frame for wall assembly If you plan a functional frame for wall assembly, you require an extra wall bracket. In this case the plinth adjusters are omitted. Max. load: 40 kg</p>							
	Functional frame for floor units	Functional frame for wall assembly	Functional frame for floor units	Functional frame for wall assembly	Functional frame for floor units	Functional frame for wall assembly	
	352	353	372	373	3102	3103	
	-	-	-	-	-	-	
<p>Lamp for functional frame The functional frame can be fitted with an optional LED lamp. LED lamp incl. footswitch. Lamp switch optionally with a remote control unit (against surcharge). Later fitting is not possible. This luminaire contains built-in LED lamps of the energy classes A+++ to A. The lamps cannot be changed in the luminaire. 12 V</p>	11.0 W	15.5 W	12.5 W	18.0 W	15.0 W	23.5 W	
							
	354		374		3104		
	-		-		-		

NEW

NEW

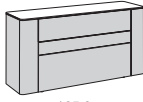
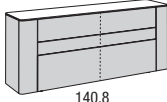
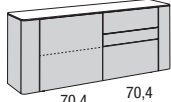
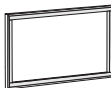
4 Raster units with rounded end at both sides

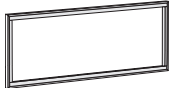
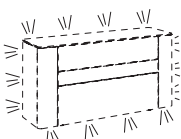
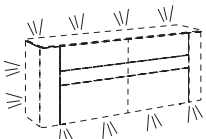
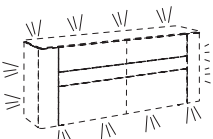
<p>4 Raster units with rounded end at both sides 71.4 cm high (73.2 cm high incl. 1.8 cm high plinth adjusters), 45.0 cm deep</p>	<p style="text-align: center;">4 Raster units with rounded end at both sides</p>						
	 <p style="text-align: center;">105,6</p> <p style="text-align: center;">140.8 cm wide</p>		 <p style="text-align: center;">140,8</p> <p style="text-align: center;">176.0 cm wide</p>		 <p style="text-align: center;">70,4 70,4</p> <p style="text-align: center;">176.0 cm wide</p>		
	Flap hinge at bottom	3 drawers	Top/Centre: 2 drawers Bottom: 1 flap	3 drawers with split drawer frames	Top/Centre: 2 drawers with split drawer frames Bottom: 1 flap with 1 partition	Left: 1 door Right: 3 drawers	Left: 1 door Top right/Centre: 2 drawers Bottom right: 1 flap
	as illustr. v. versa	4442	4443	4461	4462	44631 44632	44641 44642
Price gr. I II	-	-	-	-	-	-	
NEW Drawer for end unit optionally left (L) and/or right (R)	491L	492R	491L	492R	491L	492R	
NEW Hinge-door for end unit optionally left (L) and/or right (R)	481L	482R	481L	482R	481L	482R	
Wall bracket If units are planned as wall units, a wall bracket must be ordered. Max. load: 40 kg	2105		2145		2145		
<p>Functional frame for floor units The units can be planned optionally with a functional frame for floor units.</p> <p>Functional frame for wall assembly If you plan a functional frame for wall assembly, you require an extra wall bracket. In this case the plinth adjusters are omitted. Max. load: 40 kg</p>							
	Functional frame for floor units	Functional frame for wall assembly	Functional frame for floor units	Functional frame for wall assembly	Functional frame for floor units	Functional frame for wall assembly	
	4102	4103	4142	4143	4142	4143	
<p>Lamp for functional frame The functional frame can be fitted with an optional LED lamp. LED lamp incl. footswitch. Lamp switch optionally with a remote control unit (against surcharge). Later fitting is not possible. This luminaire contains built-in LED lamps of the energy classes A+++ to A. The lamps cannot be changed in the luminaire. 12 V</p>	17.5 W	26.0 W	18.5 W	27.0 W	18.5 W	27.0 W	
							
	4104		4144		4144		

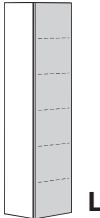
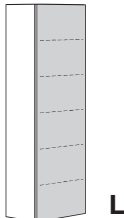
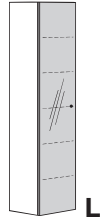
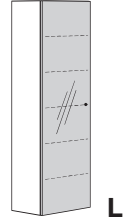

12 Raster units

<p>12 Raster units 211.2 cm high (213.0 cm high incl. 1.8 cm high plinth adjusters), 45.0 cm deep</p> <p>Mirror doors with handle in stainless steel look</p>	 <p>52.8 cm wide</p>		 <p>70.4 cm wide</p>	
	1 door		1 door	
	<p>124511 L 124512 R</p>		<p>124711 L 124712 R</p>	
	<p>Price gr. I II</p>	-	-	-
	 <p>52.8 cm wide</p>		 <p>70.4 cm wide</p>	
	1 mirror door		1 mirror door	
	<p>124521 L 124522 R</p>		<p>124721 L 124722 R</p>	
	<p>Price gr. I II</p>	-	-	-

Wall bracket

<p>If units are to be included as wall units, a wall bracket must be ordered. If units are stacked on top of one another, a wall bracket is only to be ordered for the stacked unit(s) if the stacked unit is wider than the floor unit or if the units are stacked in an off-set position.</p>	for 52.8 cm width	for 70.4 cm width
	<p>255</p> <p>-</p>	<p>275</p> <p>-</p>

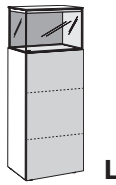
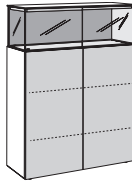

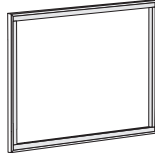
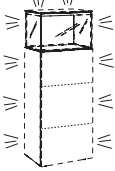
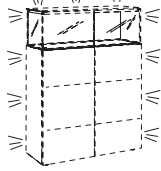
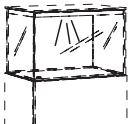
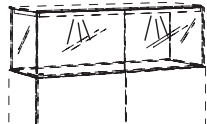



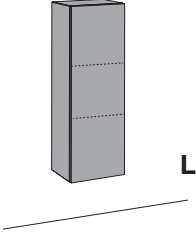
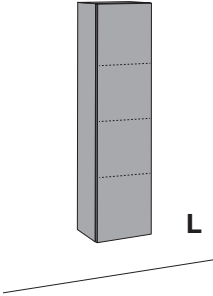
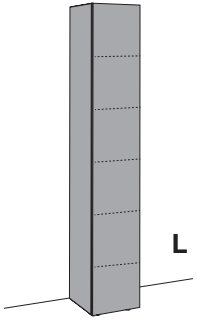
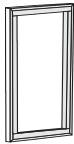
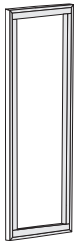
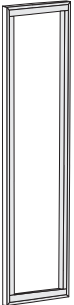
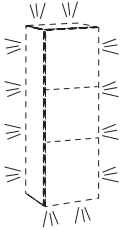
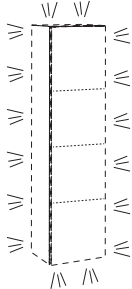
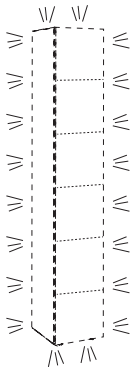

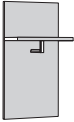
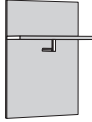

8 Raster units with accent rear wall

<p>8 Raster units with accent rear wall 141.8 cm high (143.6 cm high incl. 1.8 cm high plinth adjusters), 45.0 cm deep</p> <p>Cannot be fitted as a wall unit!</p>	<p>8 Raster units with accent rear wall</p>	
	 <p>52.8 cm wide 1 door with glass panel</p>	 <p>105.6 cm wide 2 doors with glass panel</p>
	<p>84551 L 84552 R</p> <p>Price gr. I - II -</p>	<p>8411</p> <p>-</p>
<p>Functional frame for floor units The units can be planned optionally with a functional frame for floor units.</p>	 <p>Functional frame for floor units</p>	 <p>Functional frame for floor units</p>
	<p>852</p> <p>-</p>	<p>81020</p> <p>-</p>
<p>Lamp for functional frame The functional frame can be fitted with an optional LED lamp. LED lamp incl. footswitch. Lamp switch optionally with a remote control unit (against surcharge). Later fitting is not possible.</p> <p>This luminaire contains built-in LED lamps of the energy classes A++ to A. The lamps cannot be changed in the luminaire. 12 V</p>	<p>21.5 W</p>  <p>854</p> <p>-</p>	<p>25.5 W</p>  <p>81040</p> <p>-</p>
<p>Integrated LED spotlamps for cabinets Ø 7.1 cm The cabinets can be fitted with optional integrated LED spotlamps. Integrated LED spotlamps incl. footswitch. Lamp switch optionally with a remote control unit (against surcharge).</p> <p>This luminaire contains built-in LED lamps of the energy classes A++ to A. The lamps cannot be changed in the luminaire. 12 V</p> <p>Note: For type 8411 two integrated LED spotlamps must be ordered!</p>	<p>2.9 W</p>  <p>7941</p> <p>-</p>	<p>2x 2.9 W</p>  <p>For type 8411 two integrated LED spotlamps must be ordered!</p> <p>2x 7941 2x -</p>

6, 8 and 12 Raster accent units

<p>6 Raster wall accent unit 105.6 cm high; 33.0 cm deep</p> <p>8 Raster wall accent unit 140.8 cm high; 33.0 cm deep</p> <p>12 Raster floor accent unit 211.2 cm high (213.0 cm high incl. 1.8 cm high plinth adjusters); 45.0 cm deep</p>		<p>6 Raster wall accent unit</p>	<p>8 Raster wall accent unit</p>	<p>12 Raster floor accent unit</p>
		 <p>35.2 cm wide</p>	 <p>35.2 cm wide</p>	 <p>35.2 cm wide</p>
		<p>1 door; 2 fitted shelves</p>	<p>1 door; 3 fitted shelves</p>	<p>1 door; 5 fitted shelves</p>
	<p>Price gr. I II III</p>	<p>63351 L 63352 R</p> <p>- - -</p>	<p>83351 L 83352 R</p> <p>- - -</p>	<p>124351 L 124352 R</p> <p>- - -</p>
<p>Functional frame for wall assembly If you plan a functional frame for wall assembly for the wall accent units, you do not require an extra wall bracket.</p> <p>Max. load: 20 kg</p> <p>Functional frame for floor units The units can be planned optionally with a functional frame for floor units.</p>				
		<p>Functional frame for wall assembly</p>	<p>Functional frame for wall assembly</p>	<p>Functional frame for floor units</p>
<p>Lamp for functional frame The functional frame can be fitted with an optional LED lamp. LED lamp incl. footswitch. Lamp switch optionally with a remote control unit (against surcharge). Later fitting is not possible.</p> <p>This luminaire contains built-in LED lamps of the energy classes A++ to A. The lamps cannot be changed in the luminaire. 12 V</p>		<p>19.5 W</p> 	<p>22.5 W</p> 	<p>28.5 W</p> 
		<p>634</p> <p>-</p>	<p>834</p> <p>-</p>	<p>12340</p> <p>-</p>

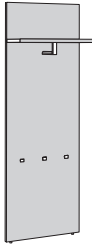
Clothes panels and mirrors

<p>4 Raster clothes panels 70.4 cm high; 3.8 cm thick; 35.0 cm deep incl. hat shelf</p> <p>Clothes rod in high-gloss chrome</p> <p>for fitting anywhere on walls</p>				
	52.8 cm wide	70.4 cm wide		
	incl. hat shelf and clothes rod	incl. hat shelf and clothes rod		
<p>6 Raster clothes panels 105.6 cm high; 3.8 cm thick; 35.0 cm deep incl. hat shelf</p> <p>Clothes rod in high-gloss chrome</p> <p>6 Raster mirrors 105.6 cm high; 0.4 cm thick; on 3.2 cm thick grey lacquered base plate</p> <p>for fitting anywhere on walls</p>				
	52.8 cm wide	70.4 cm wide	52.8 cm wide	70.4 cm wide
	incl. hat shelf and clothes rod	incl. hat shelf and clothes rod	Mirror	Mirror
<p>8 Raster mirrors 140.8 cm high; 0.4 cm thick; on 3.2 cm thick grey lacquered base plate</p> <p>for fitting anywhere on walls</p>				
			52.8 cm wide	70.4 cm wide
			Mirror	Mirror
<p>12 Raster clothes panels 211.2 cm high; 3.8 cm thick; 35.0 cm deep incl. hat shelf</p> <p>Clothes rod and bag hooks in high-gloss chrome</p> <p>12 Raster mirrors 211.2 cm high; 0.4 cm thick; on 3.2 cm thick grey lacquered base plate</p> <p>for fitting anywhere on walls</p>				
	52.8 cm wide	70.4 cm wide	52.8 cm wide	
	incl. hat shelf, clothes rod and 3 bag hooks	incl. hat shelf, clothes rod and 3 bag hooks	Mirror	
<p>Price gr.</p> <p>I</p> <p>II</p> <p>III</p>	4951	4971	5952	5972
	-	-	-	-
	-	-	-	-
<p>Price gr.</p> <p>I</p> <p>II</p> <p>III</p>	12951	12971	12952	
	-	-	-	
	-	-	-	

Fitted shelf

Fitted shelf 1.9 cm thick; for 33.0 or 45.0 cm depth					
	for 35.2 cm width		for 52.8 cm width	for 70.4 cm width	for 105.6 cm width
	for 33.0 cm depth	for 45.0 cm depth	for 45.0 cm depth	for 45.0 cm depth	for 45.0 cm depth
	133	1340	154	174	1104
Price gr.					
I	-	-	-	-	-
II	-	-	-	-	-
III	-	-	-	-	-

Shoe rack

Shoe rack 0.2 cm thick; for 45.0 cm depth of metal, silver colour anodised Required assembly height: 13.0 cm (for 52.8 cm width) resp. 9.8 cm (for 70.4 cm width)				
	for 52.8 cm width		for 70.4 cm width	
	for 45.0 cm depth		for 45.0 cm depth	
	1540		1740	
	-	-	-	-

Seat upholstery

Seat upholstery 5.0 cm high; for 45.0 cm depth Material identification: see range introduction page			
	for 52.8 cm width	for 70.4 cm width	for 105.6 cm width
	for 45.0 cm depth	for 45.0 cm depth	for 45.0 cm depth
	753	773	7103
	-	-	-

NEW

Radio remote control with change of colour temperature

The lamps are normally operated by an external foot switch. The colour temperature of the LED lamps is cold white if a foot switch is used. A 4-channel radio remote control is also available as an alternative, which is charged extra. Several lamps can be operated with each of the 4 channels. All 4 channels can be dimmed separately at the push of a button. The colour temperature of all 4 channels can be set to any level from cold white (approx. 6500 kelvin = the basic setting of the LED lamps) to warm white (approx. 2700 kelvin). If warm white is required, a radio remote control must be ordered. It is also possible to switch all channels on and off simultaneously with the "all on" or "all off" buttons. The radio remote control consists of one transmitter and one receiver. If several receivers are required because of the arrangement of the units, these and the corresponding cables are provided ex-works (no surcharge). The foot switch is omitted when the radio remote control is used.



2119

-

CLOTHES/NICHE HALLWAY UNIT



Lists of versions

Model no.	Wardrobe outer carcass and front	Price group	Model no.	Wardrobe interior carcass	Model no.	Niche compartment
648	Pure white lacquer	I	045	White lacquer	658	Natural oak
640	White lacquer	I	046	Grey lacquer	680	Core walnut
641	Grey lacquer	I				
663	Silk grey lacquer	I				
610	High-gloss pure white lacquer	II				
600	High-gloss white lacquer	II				
607	High-gloss grey lacquer	II				
614	High-gloss silk grey lacquer	II				
658	Natural oak	II				
680	Core walnut	II				

Changing versions:

With the hinge-door wardrobes and the functional hinge-door wardrobes you can choose the carcass and the front in a different version. Please state this clearly in the order. When versions from different price groups are exchanged, the higher price group is always charged.

Fabric no.	Seat upholstery
S451	Artificial leather with structure white
S453	Artificial leather with structure taupe
S455	Artificial leather with structure brown grey

Material identification artificial leather with structure:

top: 100% polyurethane, below: 41% leather, 39% polyethylene, 20% cotton

Handle versions for hinge-doors

Handle 057 / 058 Handle 058 = standard handle Handle height: 5.6 cm	Handle 011 Handle height: 24.0 cm	Handle 063 / 064 Handle height: 5.6 cm	Handle 046 / 047 Handle height: 6.3 cm	Handle 014 / 015 Handle height: 24.8 cm	Handle 012 Handle height: 24.9 cm matching version	Handle 029 / 030 Handle height: 77.0 cm	Handle 048 / 049 Handle height: 114.0 cm	Handle 026 / 013 Handle height: 114.9 cm	Handle 031 Handle height: 175.8 cm matching version	Handle 052 / 060 Handle height = door height
High-gloss chrome	Matt chrome	White lacquer	High-gloss chrome	High-gloss chrome	Matt chrome/ Wood/lacquer version	High-gloss chrome	High-gloss chrome	High-gloss chrome	Wood/lacquer version	High-gloss chrome
057 Matt chrome	011	063 Grey lacquer	047 Matt chrome	014 Matt chrome	012	029 Matt chrome	049 Matt chrome	026 Aluminium colour	031	052 Matt chrome
058		064	046	015		030	048	013		060
without surcharge	without surcharge	without surcharge	without surcharge	without surcharge	without surcharge	Surcharge per handle: -	Surcharge per handle: -	Surcharge per handle: -	Surcharge per handle: -	Surcharge per handle: -

With the **hinge-door wardrobes** you can choose between different handles. The desired handle and the desired wood/lacquer version for matching handles must always be stated in the order. Handles for high-gloss lacquer fronts are in matt lacquer in the matching colour. With the **functional hinge-door wardrobes** only handle 057/058 can be supplied.

If no details of the handle are stated in the order, the standard handle 058 is supplied.

Maximum loads

Max. loads:

- Max. load of wooden shelves (up to 58 cm width): 35 kg
- Max. load of wooden shelves (between 58 and 98 cm width): 30 kg
- Max. load of wooden shelves (from 98 cm width) as well as drawers: 25 kg
- Max. load of units when used as a seat accommodation: 120 kg for floor units.

Wall fitting

Important notes: Generally speaking, you as a dealer/qualified fitter are responsible for the correct wall mounting of the units. That is why wall mounting should only be carried out by properly trained and qualified fitters. hülsta supplies materials for mounting units on walls for nearly all the units and which should be used for safety and for constructional reasons. The assembly materials supplied by hülsta (plugs, screws) are only suitable for fitting components on to concrete in firmness class C12/15. For other materials (please see separate materials table in the wall composition chapter) we provide you with an assembly mortar set as an extra order. Please note that this assembly mortar set is also only suitable for the materials listed in the materials table. If walls are made up of other materials (e.g. plastered or lighter wall materials), one should use another method of mounting better suited to the load on site. Please note that if the units are not mounted properly on the wall, there is a risk of the units falling down or tipping over – especially when alternative mounting materials acquired on site have been used. For the reasons stated above it is absolutely essential to enquire about the composition of any walls before signing any contracts.

Suggested combinations

As an alternative to planning an individual unit from the complete range there is the possibility of choosing from specially suggested combinations. This eases planning. Incorporating accessories can enhance the suggested combinations. These are charged extra.

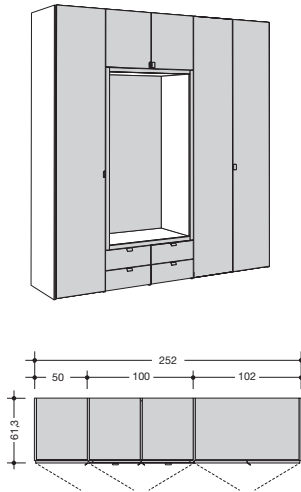

as illustr.
v. versa

981002
981102

Price gr.
I
II

-

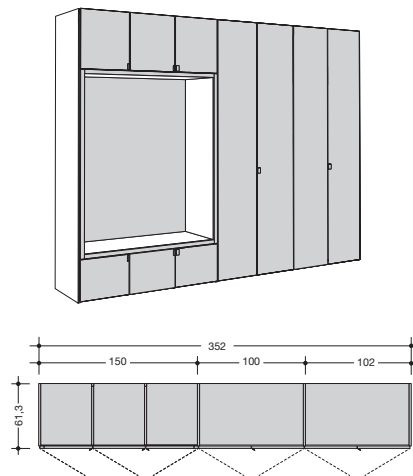

as illustr.
v. versa

981001
981101

Price gr.
I
II

-

(Functional) Hinge-door wardrobes

Notes on planning wardrobes according to the endless assembly principle

(Functional) Hinge-door wardrobes can be planned endlessly and combined with one another. Due to the various element widths one can create many total wardrobe widths. In this way the available floor space can be exploited to the full. For each wardrobe combination, the first element on the left is considered to be the basic unit, incorporating both outer side-sections. One can only include one basic unit in each combination. When adding on extension units, the right-hand side-section of the basic unit is employed as the end side-section of the complete combination. In the case of single-door (functional) hinge-door units one can choose between left- and right-hand hinges. The graphics shown below give you an excerpt from our wardrobe assortment.

Standard interior fittings per unit: 2 fitted shelves, 1 clothes rod.

Wardrobe interior fittings optionally in white lacquer (standard) or grey lacquer. Please state in the order!

Wardrobe examples for (functional) hinge-door wardrobes

**Clothes/niche hallway unit
Hinge-door wardrobes**

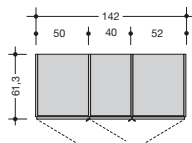
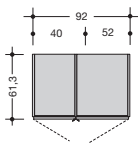
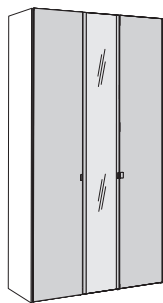
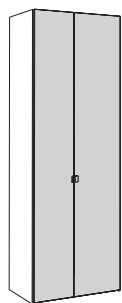

- Hinge-door wardrobes and functional hinge-door wardrobes can be planned endlessly and combined with one another
- Optionally available with many different handles
- Mirror fronts for hinge-door wardrobes against surcharge
- Wardrobe height: 268.0 cm
- Unit outside widths:
52, 82, 102, 152 cm (basic units)
50, 80, 100, 150 cm (extension units)
- Unit inside widths: 48, 78, 98 cm
- Outside depth: 61.3 cm
- Inside depth: 56.0 cm

Height, width and depth reductions for hinge-door wardrobes

- Height reductions at intervals of 1 mm, width and depth reductions at intervals of 1.0 cm without surcharge.

Height and depth reductions for functional hinge-door wardrobes

- Height reductions (done on upper doors):
Above the niche between 268.0 and 247.2 cm hinge-doors are still fitted.
Above the niche between 247.1 and 224.0 cm a fixed cover panel is fitted (compartments not accessible).
- Depth reductions are possible up to a max. 12.0 cm. In this case drawers with a frame depth of 38.0 cm are fitted.
- Width reductions are not possible.

**Clothes/niche hallway unit
Functional hinge-door wardrobes**

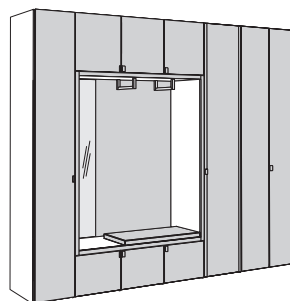
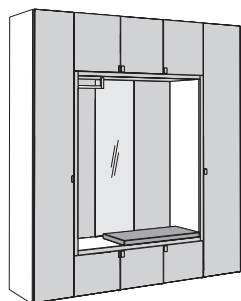
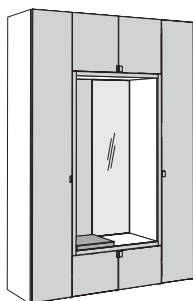

The niche of the functional hinge-door wardrobes can be fitted out partly or completely with seat upholstery and/or niche mirrors.

Clothes rods can be fitted lengthwise or transversely at the top of the niche.

If the clothes rod is fitted lengthwise and/or the clothes/niche hallway unit is required in a special depth, then it is not possible to fit integrated LED spotlamps.

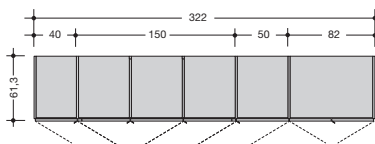
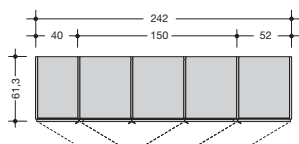
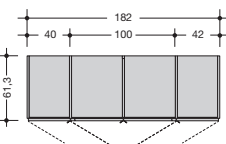

Height: 268.0 cm
Width: see table
Depth: 61.3 cm

Hinge-door wardrobes

<p>Basic units with 2 outer side-sections (each 2 cm thick)</p> <p>For each wardrobe combination, the first element on the left is considered to be the basic unit, incorporating both outer side-sections. One can only include one basic unit in each combination. When adding on extension units, the right-hand side-section is employed as the end side-section.</p>		<p>Extension units with 1 centre partition (2 cm thick)</p>		<p>Surcharge for mirror</p> <p>Each wardrobe door can be optionally fitted with a mirror for which a surcharge is made.</p>	
<p>Single-door unit, left or right, 42 cm wide</p>	<p>Price gr. I II</p>	<p>A3011 L A3012 R</p> <p>- -</p>	<p>Single-door unit, left or right, 40 cm wide</p>	<p>Price gr. I II</p>	<p>A01011 L A01012 R</p> <p>- -</p>
<p>Single-door unit, left or right, 52 cm wide</p>	<p>Price gr. I II</p>	<p>A3011 L A3012 R</p> <p>- -</p>	<p>Single-door unit, left or right, 50 cm wide</p>	<p>Price gr. I II</p>	<p>A1011 L A1012 R</p> <p>- -</p>
<p>Twin-door unit, 82 cm wide</p>	<p>Price gr. I II</p>	<p>A0302</p> <p>- -</p>	<p>Twin-door unit, 80 cm wide</p>	<p>Price gr. I II</p>	<p>A0102</p> <p>- -</p>
<p>Twin-door unit, 102 cm wide</p>	<p>Price gr. I II</p>	<p>A302</p> <p>- -</p>	<p>Twin-door unit, 100 cm wide</p>	<p>Price gr. I II</p>	<p>A102</p> <p>- -</p>

Please mark exactly in the front sketch or state in the order (from the left) which hinge-doors are to be fitted with a mirror.
Surcharge for mirror per hinge-door:
-

Height: 268.0 cm
Width: see table
Depth: 61.3 cm

Functional hinge-door wardrobes

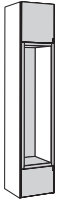
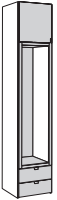
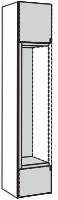
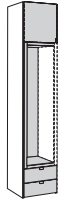
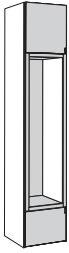
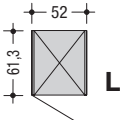
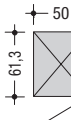
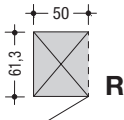
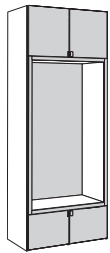
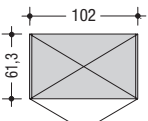
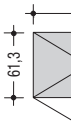
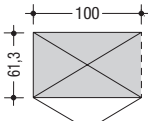
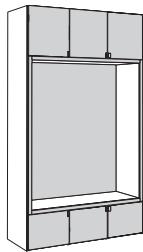
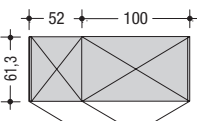
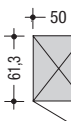
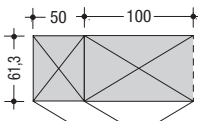
<p>Basic units with 2 outer side-sections (each 2 cm thick)</p> <p>For each wardrobe combination, the first element on the left is considered to be the basic unit, incorporating both outer side-sections. One can only include one basic unit in each combination. When adding on extension units, the right-hand side-section is employed as the end side-section.</p>	<p>above and below niche: doors</p> 	<p>above niche: doors below niche: drawers</p> 	<p>Extension units with 1 centre partition (2 cm thick)</p>	<p>above and below niche: doors</p> 	<p>above niche: doors below niche: drawers</p> 		
<p>Single-door unit, left or right, 52 cm wide</p>   <p>Illustration: Door below niche</p>	<p>Price gr. I II</p>	<p>A3171 L A3172 R</p> <p>- -</p>	<p>A3181 L A3182 R</p> <p>- -</p>	<p>Single-door unit, left or right, 50 cm wide</p>  	<p>Price gr. I II</p>	<p>A1171 L A1172 R</p> <p>- -</p>	<p>A1181 L A1182 R</p> <p>- -</p>
<p>Twin-door unit, 102 cm wide</p>   <p>Illustration: Doors below niche</p>	<p>Price gr. I II</p>	<p>A327</p> <p>- -</p>	<p>A328</p> <p>- -</p>	<p>Twin-door unit, 100 cm wide</p>  	<p>Price gr. I II</p>	<p>A127</p> <p>- -</p>	<p>A128</p> <p>- -</p>
<p>Triple-door unit, 152 cm wide</p>   <p>Illustration: Doors below niche</p>	<p>as illustr. v. versa</p> <p>Price gr. I II</p>	<p>A3371 A3372</p> <p>- -</p>	<p>A3381 A3382</p> <p>- -</p>	<p>Triple-door unit, 150 cm wide</p>  	<p>as illustr. v. versa</p> <p>Price gr. I II</p>	<p>A1371 A1372</p> <p>- -</p>	<p>A1381 A1382</p> <p>- -</p>

Seat upholstery

<p>Seat upholstery 5.0 cm high; 44.0 cm deep</p> <p>fittable in niche of functional hinge-door wardrobes</p> <p>The niche can be fitted out partly or completely with seat upholstery.</p> <p>Material identification: see range introduction page</p>			
	<p>for 50 cm wide niche (40.8 cm wide)</p>	<p>for 100 cm wide niche (90.8 cm wide)</p>	<p>for 150 cm wide niche (139.8 cm wide)</p>
	<p>350 -</p>	<p>3100 -</p>	<p>3150 -</p>

Niche mirror, clothes rod

<p>Niche mirror 164.2 cm high; 0.3 cm thick</p> <p>Clothes rod 10.6 cm high; 35.8 cm wide; 2.5 cm deep</p> <p>fittable in niche of functional hinge-door wardrobes</p> <p>The niche can be fitted out partly or completely with niche mirrors.</p> <p>The clothes rod can be fitted lengthwise or transversely at the top of the niche. If the clothes rod is fitted lengthwise and/or the clothes/niche hallway unit is required in a special depth, then it is not possible to fit integrated LED spotlamps.</p>		
	<p>for 50 cm wide niche</p>	<p>Illustration: lengthwise assembly Illustration: transverse assembly for 50 cm wide niche</p>
	<p>450 -</p>	<p>650 -</p>

Lamps

<p>This luminaire contains built-in LED lamps of the energy classes A++ to A. The lamps cannot be changed in the luminaire. 12 V</p>	<p>LED lamps incl. foot switch. A radio remote control is possible for operation (against a surcharge).</p>
<p>Integrated LED spotlamp Ø 7.1 cm; for fitting in niches</p> <p>Later fitting is not possible.</p>	
	<p>2.9 W</p> <p>7941 -</p>

NEW







Radio remote control with change of colour temperature

The lamps are normally operated by an external foot switch. The colour temperature of the LED lamps is cold white if a foot switch is used. A 4-channel radio remote control is also available as an alternative, which is charged extra. Several lamps can be operated with each of the 4 channels. All 4 channels can be dimmed separately at the push of a button. The colour temperature of all 4 channels can be set to any level from cold white (approx. 6500 kelvin = the basic setting of the LED lamps) to warm white (approx. 2700 kelvin). If warm white is required, a radio remote control must be ordered. It is also possible to switch all channels on and off simultaneously with the "all on" or "all off" buttons. The radio remote control consists of one transmitter and one receiver. If several receivers are required because of the arrangement of the units, these and the corresponding cables are provided ex-works (no surcharge). The foot switch is omitted when the radio remote control is used.



2119
-





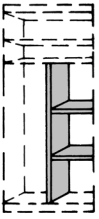
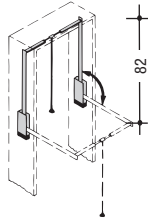

Wardrobe interior fittings

	for wardrobe inside widths	Type no.	
 <p>Fitted shelf 2.3 cm thick</p>	38 cm 48 cm 78 cm 98 cm	79002 79003 79004 79006	- - - -
 <p>Extendable fitted shelf 7.2 cm high</p>	48 cm 78 cm 98 cm	79403 79404 79406	- - -
<p>Surcharge for extendable fitted shelf in special width</p>		99910	-
 <p>Illuminated LED shelf 2.9 cm thick; with LED-lamp; with automatic switch and motion detector</p> <p>This luminaire contains builtin LED lamps of the energy classes A++ to A. The lamps cannot be changed in the luminaire. 12 V; 3.4-9.0 W</p>	38 cm 48 cm 78 cm 98 cm	79332 79333 79334 79336	- - - -
 <p>Presentation shelf 2.3 cm thick; with extra slat on the front rim, 6.0 cm high</p> <p>Fitted height: approx. 17.5 cm when fitted at an angle</p>	48 cm 78 cm 98 cm	79503 79504 79506	- - -
 <p>Protective mat of silver-coloured plastic; for presentation shelves</p>	48 cm 78 cm 98 cm	79563 79564 79566	- - -
 <p>Clothes rod chrome, uniform tubular metal with two supports</p>	38 cm 48 cm 78 cm 98 cm	79012 79013 79014 79016	- - - -
 <p>Inside mirror fitted on the inner side of 268.0 cm high and 50 cm wide hinge-doors</p> <p>Please state clearly in the order which hinge-doors are to be fitted with an inside mirror.</p>		79154	-



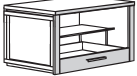

Wardrobe interior fittings

	for wardrobe inside widths	Type no.	
 <p>Centre partition kit for wardrobes with unit inside widths of 78 and 98 cm, consisting of:</p> <p>1 centre partition (153.0 cm high); 2 constructional shelves 48 cm wide (fitted optionally left or right)</p> <p>for 78 cm width: 48 cm wide compartment with 2 constructional shelves; 28 cm open compartment</p> <p>for 98 cm width: 48 cm wide compartment with 2 constructional shelves; 48 cm open compartment</p> <p>Additional extras: 48 cm wide fitted shelves, clothes rods and sets</p>		79130	-
 <p>Clothes lift Twin-arm, aluminium-coloured, swing-out clothes rod with brake mechanism</p> <p>Max. load: 10 kg</p>	78 cm 98 cm	79184 79186	- -

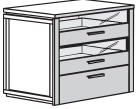
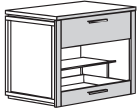

Wardrobe interior fittings

<p>Sets of drawers Sets of drawers as a complete unit consisting of top cover shelf, block sides and different drawers. If sets of drawers are stacked, the cover shelf of the bottom set of drawers is omitted and can be deducted from the price. A cover for a set of drawers must be fitted for mounting the units as stand-alone units at one side. If 2 sets of drawers are fitted adjacently please use the centre partition kit. Accessories: see page 49!</p>		for wardrobe inside widths	Type no.	
 <p>Set 1 1 drawer with wooden front</p>	Total height: 21.5 cm	48 cm 78 cm 98 cm	60013 60014 60016	- - -
 <p>Set 2 1 drawer with glass front</p>	Total height: 21.5 cm	48 cm 78 cm 98 cm	60023 60024 60026	- - -
 <p>Set 3 1 shoe drawer</p>	Total height: 40.7 cm	78 cm 98 cm	60034 60036	- -
 <p>Set 4 2 drawers with wooden front</p>	Total height: 40.7 cm	48 cm 78 cm 98 cm	60043 60044 60046	- - -
 <p>Set 5 1 drawer with glass front 1 drawer with wooden front</p>	Total height: 40.7 cm	48 cm 78 cm 98 cm	60053 60054 60056	- - -
 <p>Set 6 2 drawers with glass front</p>	Total height: 40.7 cm	48 cm 78 cm 98 cm	60063 60064 60066	- - -

Wardrobe interior fittings

Sets of drawers Sets of drawers as a complete unit consisting of top cover shelf, block sides and different drawers. If sets of drawers are stacked, the cover shelf of the bottom set of drawers is omitted and can be deducted from the price. A cover for a set of drawers must be fitted for mounting the units as stand-alone units at one side. If 2 sets of drawers are fitted adjacently please use the centre partition kit. Accessories: see page 49!		for wardrobe inside widths	Type no.	
 <p>Set 7 3 drawers with wooden front</p>	Total height: 59.9 cm	48 cm 78 cm 98 cm	60073 60074 60076	- - -
 <p>Set 8 1 drawer with glass front 2 drawers with wooden front</p>	Total height: 59.9 cm	48 cm 78 cm 98 cm	60083 60084 60086	- - -
 <p>Set 9 2 drawers with glass front 1 drawer with wooden front</p>	Total height: 59.9 cm	48 cm 78 cm 98 cm	60093 60094 60096	- - -
 <p>Set 10 1 drawer with wooden front 1 shoe drawer</p>	Total height: 59.9 cm	78 cm 98 cm	60104 60106	- -
 <p>Set 11 4 drawers with wooden front</p>	Total height: 79.1 cm	48 cm 78 cm 98 cm	60113 60114 60116	- - -
 <p>Set 12 1 drawer with glass front 3 drawers with wooden front</p>	Total height: 79.1 cm	48 cm 78 cm 98 cm	60123 60124 60126	- - -

Wardrobe interior fittings

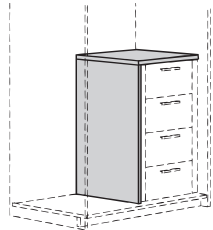
Accessories The drawers in the sets of drawers can be fitted with drawer compartments.		for wardrobe inside widths	Type no.	
 <p>Drawer compartment A We recommend only fitting these compartments in drawers with glass fronts. 5.6 cm high</p> <p>Number of compartments for 48 cm width: 12 for 78 cm width: 24 for 98 cm width: 32</p>		48 cm	49283	-
		78 cm	49284	-
		98 cm	49286	-
 <p>Drawer compartment B We recommend only fitting these compartments in drawers with glass fronts. 5.6 cm high</p> <p>Number of compartments for 48 cm width: 6 for 78 cm width: 15 for 98 cm width: 15</p>		48 cm	49293	-
		78 cm	49294	-
		98 cm	49296	-
 <p>Cover for sets of drawers</p>	for 1 Raster height	48 cm 78 cm 98 cm	40413 40414 40416	- - -
	for 2 Raster height	48 cm 78 cm 98 cm	40423 40424 40426	- - -
	for 3 Raster height	48 cm 78 cm 98 cm	40433 40434 40436	- - -
	for 4 Raster height	48 cm 78 cm 98 cm	40443 40444 40446	- - -

Technical notes on clothes/niche hallway unit

If the on-site situation has been clarified (also see the following page), the required dimensions must be calculated. The situation/view is the key here.

View 1
right-angled

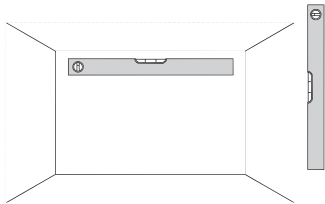

View 2
with 1 or 2 slopes

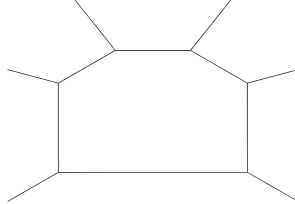

1.) Floor

Example 1
Floor absolutely horizontal
= everything O.K.

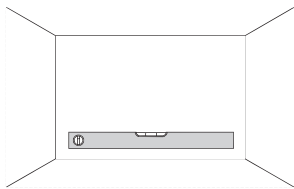

O.K.

Example 2
Floor (with absolutely horizontal ceiling) has max. 8 mm height difference per metre length
= everything O.K.

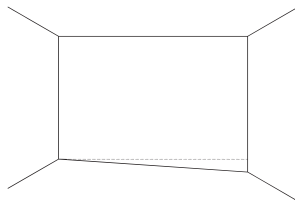

O.K.

Example 3
Floor has more than 8 mm height difference per metre length = this difference must be equalised effectively on-site. If both the floor and ceiling betray differences in height, the sum of these height differences per metre length must not exceed 8 mm.

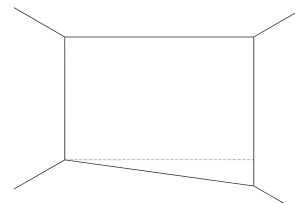

Not O.K.

Difference must be balanced effectively on-site.

2.) Ceiling

Example 4
Ceiling absolutely horizontal
= everything O.K.

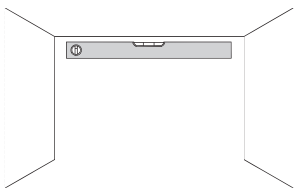

O.K.

Example 5
Ceiling (with absolutely horizontal floor) has max. 8 mm height difference per metre length
= everything O.K.

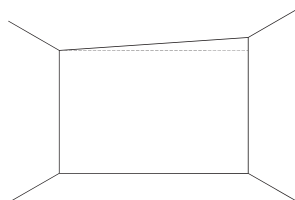

O.K.

Example 6
Ceiling has more than 8 mm height difference per metre length = this difference must be equalised effectively on-site. If both the floor and ceiling betray differences in height, the sum of these height differences per metre length must not exceed 8 mm.

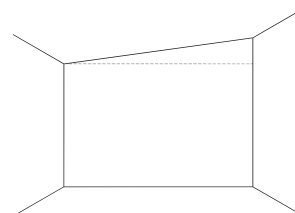

Not O.K.

Difference must be balanced effectively on-site (e.g. with panel material; see here the following double page).

3.) Walls

Example 7
Walls absolutely vertical
= everything O.K.

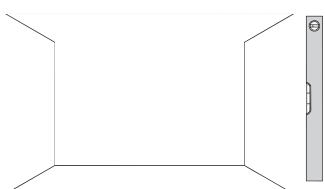

O.K.

Example 8
Walls are not vertical = this difference must be equalised effectively on-site.

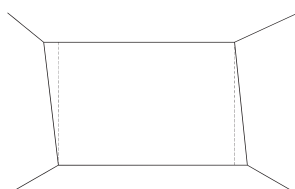

Not O.K.

Difference must be balanced effectively on-site (e.g. with panel material; see here the following double page).

Measuring heights

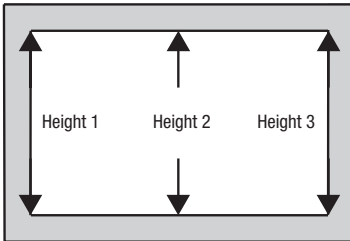

Please measure height 1 and height 3 in each corner

Measuring widths

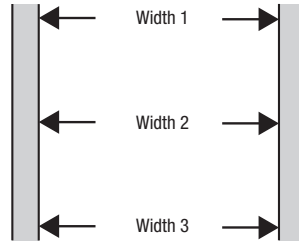

Please state all measurements in millimetres. Warm corners must be straightened on-site before measuring. Please always check all walls for quality and to see if they are exactly straight.

Maximum tolerances

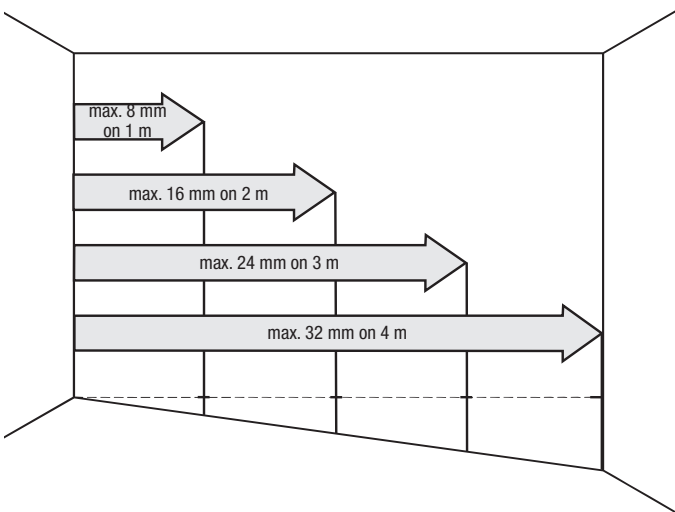

The on-site situation must be checked before you can calculate the individual sizes of the furniture units.

1.) Floor

The floor must be checked to see if it is horizontal using a spirit level. An absolutely horizontal floor (see example 1) is best. The MULTI-DIELE clothes/niche hallway unit, however, will permit height differences in the floor of a **maximum 8 mm per 1 m length** (i.e. 16 mm for a max. width of 2 m, 24 mm for a max. width of 3 m, etc.; see example 2). The various maximum tolerances cannot be added up.

If the maximum tolerance value of 8 mm per 1 m length is exceeded (see example 3), this difference must be equalised suitably on-site.

2.) Ceiling

The ceiling must be checked to see if it is horizontal using a spirit level. An absolutely horizontal ceiling (see example 4) is best. The MULTI-DIELE clothes/niche hallway unit, however, will permit height differences in the ceiling of a **maximum 8 mm per 1 m length** (i.e. 16 mm for a max. width of 2 m, 24 mm for a max. width of 3 m, etc.; see example 5). The various maximum tolerances cannot be added up.

If the maximum tolerance value of 8 mm per 1 m length is exceeded (see example 6), this difference must be equalised suitably on-site.

3.) Walls

The walls must be checked to see if they are vertical using a spirit level. The walls must be absolutely vertical (see example 7). If they are not (see example 8), this difference must be equalised suitably on-site.

Important notes: Generally speaking, you as a dealer/qualified fitter are responsible for the correct wall mounting of the units. That is why wall mounting should only be carried out by properly trained and qualified fitters. hüsta supplies materials for mounting units on walls for nearly all the units and which should be used for safety and for constructional reasons. The assembly materials supplied by hüsta (plugs, screws) are only suitable for fitting components on to concrete in firmness class C12/15. For other materials (please see separate materials table in the wall composition chapter) we provide you with an assembly mortar set as an extra order. Please note that this assembly mortar set is also only suitable for the materials listed in the materials table. If walls are made up of other materials (e.g. plastered or lighter wall materials), one should use another method of mounting better suited to the load on site. Please note that if the units are not mounted properly on the wall, there is a risk of the units falling down or tipping over – especially when alternative mounting materials acquired on site have been used. For the reasons stated above it is absolutely essential to enquire about the composition of any walls before signing any contracts.

Radio remote control with change of colour temperature

The lamps are normally operated by an external foot switch. The colour temperature of the LED lamps is cold white if a foot switch is used. A 4-channel radio remote control is also available as an alternative, which is charged extra. Several lamps can be operated with each of the 4 channels. All 4 channels can be dimmed separately at the push of a button. The colour temperature of all 4 channels can be set to any level from cold white (approx. 6500 kelvin = the basic setting of the LED lamps) to warm white (approx. 2700 kelvin). If warm white is required, a radio remote control must be ordered. It is also possible to switch all channels on and off simultaneously with the "all on" or "all off" buttons. The radio remote control consists of one transmitter and one receiver. If several receivers are required because of the arrangement of the units, these and the corresponding cables are provided ex-works (no surcharge). The foot switch is omitted when the radio remote control is used.

The following points must be noted with the radio remote control:

- The receiver must be positioned behind a rear wall or under plinth shelves (at least 20 mm space required under plinth shelves).
- The total wattage power of all lamps included per receiver must not exceed 30 W.
- 4 channels = 4 light groups
- 1 light group = x lights
- All lamps within a light group can be dimmed to the same brightness.
- The change of the colour temperature takes place for all lamps in all light groups.
- The radio remote control is not suitable for equipment operating on 110 V.

Please be sure to note the operating and programming instructions!

4-channel radio remote control with change of color temperature



4-channel radio remote control with change of color temperature

Type	2119	-
------	------	---

Examples of use (schematic diagrams)

Example 1

Lights inside a unit

Channel 1 operates (and dims) all the lights in light group 1, i.e. the LED spotlamp in the left cabinet

Channel 2 operates (and dims) all the lights in light group 2, i.e. the LED spotlamps in the open compartment

Channel 3 operates (and dims) all the lights in light group 3, i.e. the LED spotlamp in the right cabinet

Notes:

The total wattage power of all lamps included per receiver must not exceed 30 W. The change of the colour temperature takes place for all lamps in all light groups.

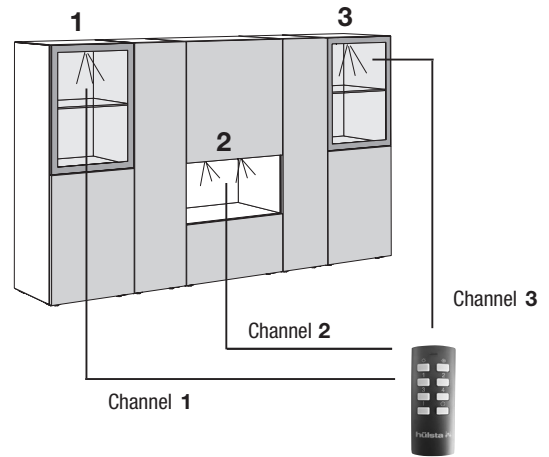

Example 2

Lights in units set apart

Channel 1 operates (and dims) all the lights in light group 1, i.e. the LED spotlamp and the LED light panels in the left cabinet

Channel 2 operates (and dims) all the lights in light group 2, i.e. the LED spotlamps and the LED light panels in the centre cabinet

Channel 3 operates (and dims) all the lights in light group 3, i.e. the LED spotlamp and the LED light panels in the right cabinet

Notes:

The total wattage power of all lamps included per receiver must not exceed 30 W. The change of the colour temperature takes place for all lamps in all light groups.

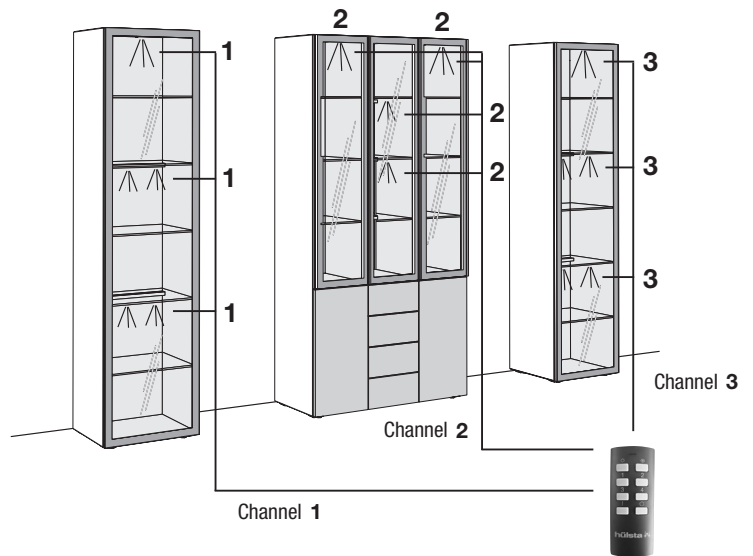

Example 3

Lights in units set apart

Channel 1 operates (and dims) all the lights in light group 1, i.e. the LED spotlamps in the left, centre and right cabinet

Channel 2 operates (and dims) all the lights in light group 2, i.e. the top LED light panels in the left, centre and right cabinet

Channel 3 operates (and dims) all the lights in light group 3, i.e. the bottom LED light panels in the left, centre and right cabinet

Notes:

The total wattage power of all lamps included per receiver must not exceed 30 W. The change of the colour temperature takes place for all lamps in all light groups.

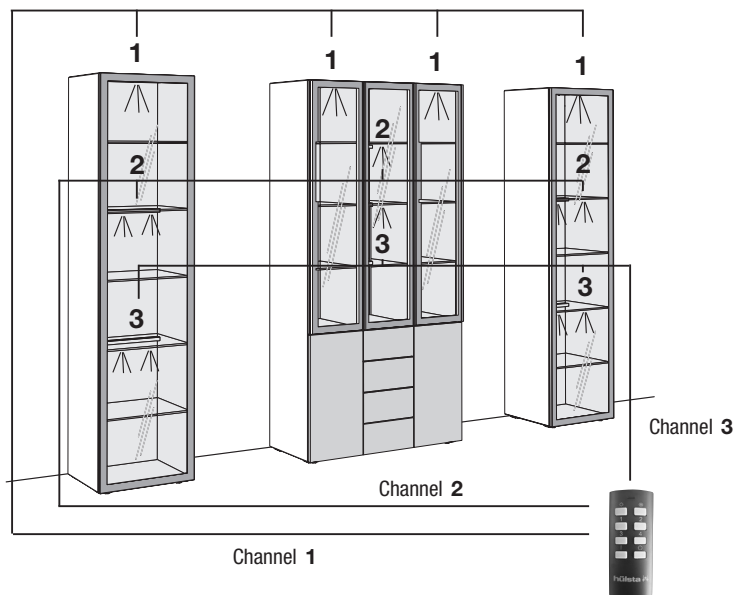

Special heights, special widths, special depths

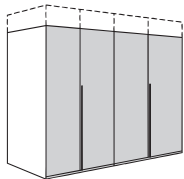

Special heights

- Hinge-, folding- and sliding-door wardrobes can be reduced in height at intervals of 1.0 cm.
- Below eye-level we recommend fitting a top cover shelf made of panelling material. Please state in order!
- Special heights in stepped versions (not possible on sliding-door wardrobes) at a surcharge.

Surcharge per step:

00030

-

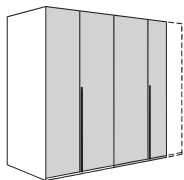

Special widths

Only applies to hinge- and folding-door wardrobes

- Single-door units, left or right hinges, can be reduced down to 25 cm width (apart from profiled doors).
- Twin-door units can be reduced at both sides down to 50 cm total width (apart from profiled doors).
- Interior fittings such as drawers and other fittings cannot be reduced in width.
- For notes on width reductions on MULTI-FORMA II sliding-door wardrobes please see special-sized products for MULTI-FORMA II!

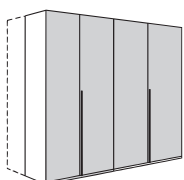

Special depths

- Depth reductions are made on side sections, plinths, cornices and shelves.
- Interior fittings such as drawers and other fittings cannot be reduced in depth.
- A max. reduction of 30.0 cm is possible on hinge- and folding-door wardrobes.
- A max. reduction of 9.0 cm is possible on profiled hinge-doors.
- For sliding-door wardrobes, a max. reduction of 30.0 cm is possible (max. 18 cm in combination with the electrical opening system for MULTI-FORMA II).
- Please note that for technical production reasons not every special depth can be achieved:
 2.5 cm standard reduction between 0 and 2.5 cm
 5.0 cm standard reduction between 4.5 and 5.0 cm
 27.5 cm standard reduction between 27.0 and 27.5 cm

Notes on calculating sizes of sloping units

Side sloping

Sloping is only possible on single-door units. The door hinge (left or right) is positioned on the taller outer side of the unit.

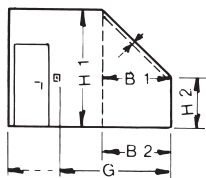
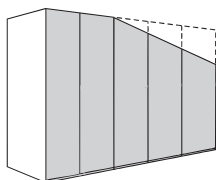

Measurements required:

- H 1 = Room height
- H 2 = Height of slope (If a space is required between the wall and the wardrobe/unit, please state the exact distance.)
- B 1 = Width of slope
- B 2 = Width of slope
- G = Total width
- S = Wardrobe width

Please note!

- If the slope cuts across the position of a handle, the handle of this door only is positioned further down in production.
- As floors, ceilings and walls are never exactly straight, the exact room size must be measured using a spirit level.
- If a cornice is fitted, please state if this is to be continued in the sloping section.

Rear sloping

Rear sloping is possible on all wardrobe units.

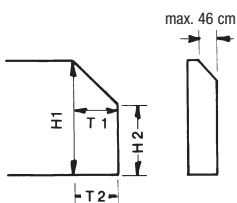
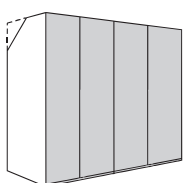

Measurements required:

- H 1 = Room height
- H 2 = Height of slope (If a space is required between the wall and the wardrobe/unit, please state the exact distance.)
- T 1 = Depth of slope
- T 2 = Depth of slope

Special-sized products

Special heights:

Hinge-door	- Wood/high-gloss lacquer	0003
Hinge-door	- Mirror	00031

Height reductions for functional hinge-door units are done on the upper doors. Above the niche between 268.0 and 247.2 cm hinge-doors are still fitted. Above the niche between 247.1 and 224.0 cm a fixed cover panel is fitted (compartments not accessible).

Special widths:

for single-door unit	- Wood/high-gloss lacquer	0005
for single-door unit	- Mirror	00051
for twin-door unit	- Wood/high-gloss lacquer	0006
for twin-door unit	- Mirror	00061

Special widths are not possible for functional hinge-door wardrobes.

When ordering extra fitted shelves and clothes rods

Size reduction per fitted shelf	9991
Size reduction per clothes rod	9992

Special depths:

per unit	0007
----------	-------------

When ordering extra fitted shelves

Size reduction per fitted shelf	9993
---------------------------------	-------------

Functional hinge-door units

Depth reduced by 12 cm	00071
------------------------	--------------

Side sloping:

Surcharge per unit	99941
--------------------	--------------

Side sloping is not possible for functional hinge-door wardrobes.

Rear sloping:

Surcharge per unit	99912
--------------------	--------------

Rear sloping of functional hinge-door wardrobes on request.

More special products are possible.

Please get in touch with your customer advisor.

Special articles

Wardrobe doors are also available as separate units and are charged as follows:

For 1 hinge-door/folding-door wing: 50% of the concerning 1-door hinge-door extension unit

For 1 sliding-door including mechanism: 35% of the twin-door sliding-door wardrobe

For door superstructures, type **100** (max. 98 cm wide, only for assembly between wardrobes): 100% of twin-door hinge-door extension unit

Panels for side and top covering of fitted wardrobes (not possible for high-gloss versions; support construction and fitting materials must be acquired on site).

For veneered/lacquered versions (max. 268.0 cm long, max. 59.0 cm wide, 2.0 cm thick)

Basis charge per order:	9901	-
+ price per m ² - lacquer	990	-
+ price per m ² - veneer	990	-

Veneer match with fronts can not be guaranteed.

Edge veneer

for veneered/lacquered versions per m. length	9902	-
---	-------------	---

165° hinges

Wardrobe doors can also be fitted with **165° hinges** against a surcharge (only possible on plain, straight hinge-doors). Please mark the doors clearly in the order!

Surcharge for 165° hinges per hinge-door:	180	-
---	------------	---

High-gloss care set

Polish, polishing sponge and polishing cloth (incl. instructions) for protecting and maintaining the high-gloss surfaces	36	-
--	-----------	---

Individual special-sized products

If the special-sized product that you require is so unusual that it cannot be illustrated with the many special sized products that we already provide and charge for, then we will quote you the price using a HK unit type factor. In your order please state for us the relevant enquiry number and the HK unit type factor stated.

HK	-
----	---

Special colours; Note on „Blue Angel“ / Emissions label of DGM**Special colours**

All the hülsta lacquer colours are possible for nearly all the hülsta ranges. Availability and prices on request.

Note on „Blue Angel“ (RAL-UZ 38) and Emissions label of DGM (Class A)

It is possible that the requirements of the „Blue Angel“ and the DGM Emissions Label cannot be met by some of the lacquer colours in price groups II and III (see here the different lacquer versions in the NURIA range), depending on the colour mix (surface ratio of these colours in the corresponding order). However, the legal requirements are definitely met in all cases!

Special-sized products

Special-sized products are possible on request.
Please get in touch with your customer advisor.

Special articles

Cover panels

for side and top panelling of fitted wardrobes (support construction and fitting materials must be acquired on site).

Basic price per order	9901	-
+ price per m ² lacquer or veneer	990	-

Veneer match with fronts can not be guaranteed.

Rim veneer

superimposed ex works or rims lacquered
for veneer and lacquer versions per m. length

9902 -

High-gloss care set

Polish, polishing sponge and polishing cloth (incl. instructions)
for protecting and maintaining the high-gloss surfaces

36 -

Individual special-sized products

If the special-sized product that you require is so unusual that it cannot be illustrated with the many special sized products that we already provide and charge for, then we will quote you the price using a HK unit type factor. In your order please state for us the relevant enquiry number and the HK unit type factor stated.

HK -

Special colours; Note on „Blue Angel“ / Emissions label of DGM

Special colours

All the hülsta lacquer colours are possible for nearly all the hülsta ranges.
Availability and prices on request.

Note on „Blue Angel“ (RAL-UZ 38) and Emissions label of DGM (Class A)

It is possible that the requirements of the „Blue Angel“ and the DGM Emissions Label cannot be met by some of the lacquer colours in price groups II and III (see here the different lacquer versions in the NURIA range), depending on the colour mix (surface ratio of these colours in the corresponding order). However, the legal requirements are definitely met in all cases!

Wall composition / assembly instruction

Important notes:

The composition of walls must be ascertained before concluding a contract and be checked by a qualified fitter before assembly takes place.







Assembly may only be carried out by a qualified fitter under careful observation of the assembly instructions.

The plastic Rawl plugs supplied by hülsta as a standard set are only suitable for concrete $\geq C12/15$, if the wall composition and compression strength corresponds to the table below. Under no circumstances must a unit be assembled on light masonry.

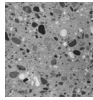
Furthermore, we provide a mounting set with assembly mortar for the types of walls listed below (see assembly mortar set below). Again, assembly must be carried out by a qualified fitter under careful observation of the wall composition and assembly instruction. The compression strength levels stated below must be met under all circumstances.

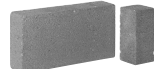
Materials table

with a description of which sets are to be used with the following types of walls:

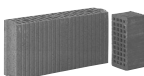
Standard set	Assembly mortar set only suitable for the materials stated below!			
<p>Concrete C12/15 Compression strength $\geq 15 \text{ N/mm}^2$</p> 	 <p>Building bricks Mz 12 Compression strength $\geq 12 \text{ N/mm}^2$</p>	 <p>Solid blocks of light concrete V2 Compression strength $\geq 2 \text{ N/mm}^2$</p>		
	 <p>Limestone blocks KS 12 Compression strength $\geq 12 \text{ N/mm}^2$</p>	 <p>Perforated blocks of light concrete Hbl 2 Compression strength $\geq 2 \text{ N/mm}^2$</p>		
	 <p>Perforated sand lime bricks KSL12 Compression strength $\geq 12 \text{ N/mm}^2$</p>	 <p>Aerated concrete PP2 Compression strength $\geq 2 \text{ N/mm}^2$</p>		
	 <p>Vertically perforated bricks HLz 12 Compression strength $\geq 12 \text{ N/mm}^2$ Bulk density $\geq 1.0 \text{ kg/dm}^3$</p>			

A different and more suitable type of mounting must be chosen by a qualified fitter in all other cases. hülsta cannot accept any responsibility for the choice of any other types of mounting! Please note that if the units are not mounted properly on the wall, there is a risk of the units falling down or tipping over – especially when alternative mounting materials acquired on site have been used. Generally speaking, you as a dealer/qualified fitter are responsible for the correct wall mounting of the units.



Mounting sets

Labelling in type list drawings / assembly notes for wall units

The majority of units have two wall mounting points (= number of support boards), if these are to be fitted as wall units. This is not explicitly mentioned in the type list. If a different number of wall mounting points (= support boards) is required, this is marked in the drawings in the type list with numbers in black boxes. Every support board requires four mounting screws.

- 3** = 3 support boards
- 4** = 4 support boards, etc.

One **assembly mortar set** is sufficient for up to a maximum of 3 support boards or 4 wall side-panels.

Important note: Depending on the composition of the wall (see wall types illustrated above), assembly must be carried out using the special assembly mortar set and a standard trade mastic tool which are the basic essentials for safe and clean workmanship.

Standard set

The standard set consists of 4 plastic Rawl plugs and 4 mounting screws and is sufficient for 1 support board. The standard sets are included in the packet of fittings to match the number of support boards.

Assembly mortar set for up to a maximum of 3 support boards consisting of:

- 9x injection retaining sleeve
- 9x screw-in sleeve
- 1x injection cartridge
- 2x static mixer
- 1x assembly instructions

Please use the mounting screws from the standard set (supplied free of charge).

Example of order:

- Add up number of support boards for all existing unit types
 - Divide the sum by “3”
 - Round up the result to a full number
- = Number of assembly mortar sets required

M2

-

Your Hotline to hülsta

Do you have any questions or require any alterations to your order confirmation?
Do you have any questions on our products or your current order?
Do you have any complaints about supplied goods or required replacement parts?
Contact Telephone: +49 (0) 2563 / 86-1627 • email: orders@huelsta.com

Do you have any questions, suggestions or wishes for the **hülsta product seminars**?
Contact Telephone: +49 (0) 2563 / 86-1493 • email: produktschulungen@huelsta.de

hülsta Planning Service

Lots to do? A customer wants his project finished and you haven't got enough time? Or the project is so complex that it will take too much time?

This is exactly the kind of situation we created the hülsta Planning Service for. hülsta's employees create the required project for you at short notice. Based on your information, we implement the project perfectly with all views and a complete order list ready for immediate forwarding to the customer.

The hülsta check list (available at <https://www.huelsta.com/einrichtungsberatung/>) makes it all really easy for you. You won't forget anything with this list and the customer receives a project he will be thrilled about as quickly as possible.

hülsta Planning Service

Tel.: +49 (0) 2563 / 86-1060

Fax: +49 (0) 2563 / 86-1000

Mail: Planungsservice-Handel@huelsta.de

Workdays from 8.00 a.m. until 6.00 p.m.

Special wishes? Come to us!

Maximum individuality! – Maximal flexibility! – hülsta makes most of your special wishes possible.
And if you do have a wish which is not quite so easy to implement, just give us a call or send us a mail or a fax. We have our own hülsta "Special Wishes Team" who are there to help you realise just these customer requests. These colleagues are professionals when it comes to special products. They plan and calculate the products possible for you and even develop an alternative suggestion if the idea should turn out to be technically impossible.

Here is an overview of the hülsta range of special wishes:

- A lot of special products can be ordered simply via the type list
- Special-sized products are planned simply and professionally
- Competent colleagues advise you by phone, by fax and by mail
- You will be sent alternative suggestions if the idea is technically impossible
- Many special-sized products are available without a surcharge
- Specially qualified carpenters and technicians implement your plans perfectly

hülsta Special Wishes Team

Tel.: +49 (0) 2563 / 86-1060

Fax: +49 (0) 2563 / 86-1417

Mail: Sonderwunsch@huelsta.com

We are open Saturdays for you, too!

Our **Saturday hotline** is available at the following times and periods:

- **15th April – 15th September** from **10.00 a.m. until 4.00 p.m.**
- **16th September – 14th April** from **10.00 a.m. until 6.00 p.m.**

Telephone: +49 (0) 2563 / 86-1800

On **working days** the hülsta Sales Department is available all day from **8.00 a.m. until 6.00 p.m.**

hülsta MULTI-DIELE

Stand: E 12.2019

Design and concept legally protected, subject to error and alterations to construction, colour and materials by way of technological progress.

hülsta-werke · Karl-Hüls-Straße 1 · D-48703 Stadtlohn
Tel. +49 (0) 2563 / 86-0 · Fax +49 (0) 2563 / 86-1000
www.huelsta.com

