

# GENTIS SLEEPING





# GENTIS SLEEPING

## Contents

	Page
Range introduction, lists of versions	2-4
Concept and possible arrangements	5-7
Special combinations	8
Hinge- and folding-door wardrobes	9-11
Design and intermediate units	12-13
Hinge-door cloakroom units	14-15
Bed system	16-17
Bed accessories	18
Consoles	19
2 and 3 Raster lowboards	20-27
Media accessories for lowboards	28
3 and 4 Raster sideboards	29-31
8 Raster highboard and cabinets	32-33
6 Raster wall unit and wall cabinet	34
Accent units	36-37
Accessories for units	38
<b>General information:</b>	
Special-sized products, special articles	40-41
Switch options for lamps	42-43
Usable bed inside height and space under bed	44
Important notes: quality of walls / assembly instruction	45

## The finest design meets natural sensuality

Fine materials and an elegant form convey an ambience of uncongested expansiveness to the room. Urban elements fusion with more rustic wooden components to form an exciting yet relaxed and aesthetic arrangement.

### Accents rearranged

Fine lacquered surfaces in a puristic look form an exciting contrast to the natural materials like unspoiled wood and soft leather.

### A wardrobe or a work of art?

The integrated accent block of highly expressive wood not only draws everyone's glances magically, it also serves as an intelligent drawer unit.

### Sleeping culture ranging from the subtle to the more expressive

There are several bed variations to choose from – the natural wood accent or the puristic wardrobe can be taken up in the bed unit. The second form is based more on soft leather applications and upholstered bed sides.

### Light and illuminating

The freely suspended ancillary units characteristic of Gentis perfectly match the elegant design form, a lamp in a variable white shade underlines the hovering effect.

## Wardrobes

Height reductions at intervals of 1.0 cm without surcharge

Hinge- and folding-door wardrobes according to the endless assembly principle

- Hinge- and folding-door wardrobes can be combined with one another
- With plain doors, with optional mirror
- With optional top LED lamp (12 V; 2.4 W)
- Design and intermediate units for a more open look
- Functional hinge-doors cloakroom units
- Drawer frames of the design and intermediate units in standard grey
- Extra-wide panorama units of folding-door wardrobes without centre partition
- Wardrobe interior carcass and wardrobe interior fittings in standard white lacquer version
- Standard interior fittings: 2 fitted shelves. 1 clothes rod
- Functional and high-quality **wardrobe interior fittings** (see „Wardrobe interior fittings“ type list)

## Beds

- Beds with headboard in wood/lacquer version and upholstered application or with upholstered headboard, bed surround in wood/lacquer version or with upholstered applications; in four widths and three lengths
- Beds optionally in a hovering look
- LED bedside lamps

In combination with the hülsta Sleeping System, the beds guarantee highest sleeping comfort. With its high-quality spring base frames and mattresses, the hülsta Sleeping System provides the perfect prerequisites for relaxing sleep (see “SLEEPING SYSTEMS“ type list).

## Ancillary units

- Console, optionally as wall unit, in one width
- A multitude of low-, side- and highboards, optionally as wall unit, cabinets and wall units in different heights and widths, numerous combinations are possible (also corner units)
- Different types of lamps

## Quality features

- Wardrobe doors with handle and high-quality spring hinges
- Visually unobtrusive 2.5 mm drilled holes for wardrobes
- Centre partitions and end side-sections of wardrobes with special plinth adjustment
- **hülsta-Push-to-open/hülsta-SoftFlow**: drawers of design units in accent version, intermediate units and ancillary units with **hülsta-Push-to-open** or bottom drawer of design units on hidden bearings incl. auto pull-in feature with brake (**hülsta-SoftFlow**)
- **hülsta-MagicClose**: All wooden hinge-doors with door cushioning system

## Lists of versions

### Wardrobes

Model no.	Wardrobe exterior carcass and front, doors of design, intermediate and hinge-doors cloakroom units	Price group	Model no.	Drawers of design units and intermediate units 1 and 2 as well as of accent unit of the hinge-doors cloakroom units	Model no.	Handle slat of wardrobe doors and intermediate unit doors
<b>648</b>	Pure white lacquer	<b>I</b>	<b>693</b>	Knotted oak	<b>131</b>	High-gloss chrome (standard)
<b>045</b>	White lacquer	<b>I</b>	<b>697</b>	Knotted oak anthracite	<b>648</b>	Pure white lacquer
<b>046</b>	Grey lacquer	<b>I</b>	<b>694</b>	Knotted core walnut	<b>045</b>	White lacquer
<b>663</b>	Silk grey lacquer	<b>I</b>	<b>51..</b>	Nappa leather (51..) *	<b>046</b>	Grey lacquer
<b>862</b>	High-gloss pure white lacquer	<b>II</b>	<b>56..</b>	Nubuk-Touch leather (56..) *	<b>663</b>	Silk grey lacquer
<b>860</b>	High-gloss white lacquer	<b>II</b>				
<b>861</b>	High-gloss grey lacquer	<b>II</b>				
<b>614</b>	High-gloss silk grey lacquer	<b>II</b>				

Wardrobe interior carcass in standard white lacquer.

\* Accent unit of hinge-doors cloakroom units is not available in leather versions!

Please state the required version clearly in the order!

### Beds

Model no.	Headboard and bed surround	Price group	Model no.	Upholstered headboard and upholstered applications
<b>648</b>	Pure white lacquer	<b>I</b>	<b>51..</b>	Nappa leather (51..)
<b>045</b>	White lacquer	<b>I</b>	<b>56..</b>	Nubuk-Touch leather (56..)
<b>046</b>	Grey lacquer	<b>I</b>		
<b>663</b>	Silk grey lacquer	<b>I</b>		
<b>693</b>	Knotted oak	<b>III</b>		
<b>697</b>	Knotted oak anthracite	<b>III</b>		
<b>694</b>	Knotted core walnut	<b>III</b>		

### Consoles, low-, side- and highboards, (wall) cabinets, wall shelf

Model no.	Carcass and front	Price group	Model no.	Accent units: Carcass and front	Price group	Model no.	Cabinet compartment rear wall
<b>648</b>	Pure white lacquer	<b>I</b>	<b>648</b>	Pure white lacquer	<b>I</b>	<b>648</b>	Pure white lacquer
<b>045</b>	White lacquer	<b>I</b>	<b>045</b>	White lacquer	<b>I</b>	<b>045</b>	White lacquer
<b>046</b>	Grey lacquer	<b>I</b>	<b>046</b>	Grey lacquer	<b>I</b>	<b>046</b>	Grey lacquer
<b>663</b>	Silk grey lacquer	<b>I</b>	<b>663</b>	Silk grey lacquer	<b>I</b>	<b>663</b>	Silk grey lacquer
<b>862</b>	High-gloss pure white lacquer	<b>II</b>	<b>862</b>	High-gloss pure white lacquer	<b>II</b>	<b>862</b>	High-gloss pure white lacquer
<b>860</b>	High-gloss white lacquer	<b>II</b>	<b>860</b>	High-gloss white lacquer	<b>II</b>	<b>860</b>	High-gloss white lacquer
<b>861</b>	High-gloss grey lacquer	<b>II</b>	<b>861</b>	High-gloss grey lacquer	<b>II</b>	<b>861</b>	High-gloss grey lacquer
<b>614</b>	High-gloss silk grey lacquer	<b>II</b>	<b>614</b>	High-gloss silk grey lacquer	<b>II</b>	<b>614</b>	High-gloss silk grey lacquer
			<b>051</b>	Natural oak	<b>II</b>	<b>051</b>	Natural oak
			<b>053</b>	Core walnut	<b>II</b>	<b>053</b>	Core walnut
			<b>693</b>	Knotted oak	<b>III</b>	<b>693</b>	Knotted oak
			<b>697</b>	Knotted oak anthracite	<b>III</b>	<b>697</b>	Knotted oak anthracite
			<b>694</b>	Knotted core walnut	<b>III</b>	<b>694</b>	Knotted core walnut
			<b>51..</b>	Nappa leather (51..)	<b>IV</b>		
			<b>56..</b>	Nubuk-Touch leather (56..)	<b>IV</b>		

The interior carcass of the versions pure white lacquer, white lacquer, high-gloss pure white lacquer and high-gloss white lacquer is in a matt white lacquer version. The same applies to the straight outer side of the lowboards with rounded end at one side.

The interior carcass of the versions grey lacquer, silk grey lacquer, high-gloss grey lacquer and high-gloss silk grey lacquer as well as of the accent units in leather version is in a matt grey lacquer version. The same applies to the straight outer side of the lowboards with rounded end at one side.

### Leather collection

Type of material	Material identification
Leather no.	Colour
<b>Leather (51..)</b>	<b>100% Nappa leather, pigmented</b>
5101	beige
5104	anthracite
5105	black
5106	red
5108	white
5109	cream
5110	mocca
5114	grey brown
5116	kiwi green
5118	chestnut brown
5119	nougat
5121	curry
5122	sand
5123	brown black
5125	grey
5126	medium mocca

Type of material	Material identification
Leather no.	Colour
<b>Nubuk-Touch leather (56..)</b>	<b>100% leather</b>
5610	white
5611	light beige
5612	khaki
5613	dark brown
5614	olive
5615	ochre
5616	anthracite
5617	black



# Range introduction

## Important notes

### Glass versions:

**Outer glass sides** of (wall) cabinets, **glass shelves** behind fronts as well as **bookshelves** and **glass accents** of wall shelf unit of bronzed glass.

**Cabinet compartment rear wall** and **rear wall** of wall shelf unit also possible in all versions (exception: leather versions).

### Accent units:

Carcase and front also in the versions knotted oak, knotted oak anthracite, knotted core walnut, Nappa leather and Nubuk-Touch leather possible (exception: accent unit of hinge-doors cloakroom units is not available in leather versions).

### Interior carcass:

The interior carcass of the versions pure white lacquer, white lacquer, high-gloss pure white lacquer and high-gloss white lacquer is in a matt white lacquer version. The same applies to the straight outer side of the lowboards with rounded end at one side. The interior carcass of the versions grey lacquer, silk grey lacquer, high-gloss grey lacquer and high-gloss silk grey lacquer as well as of the accent units in leather version is in a matt grey lacquer version. The same applies to the straight outer side of the lowboards with rounded end at one side.

### Open section of the hinge-doors cloakroom units:

The open section of the hinge-doors cloakroom units of the high-gloss lacquer versions is in a matching matt lacquer colour.

### Standard interior fittings:

Fitted wooden shelves are fitted behind doors at intervals of 2 Raster (exception: 12 Raster cabinets).

### Functional frame:

Functional frame always in white lacquer.

### Wall units:

If units are planned as wall units, a wall bracket must be ordered.

**Drawer frames** in standard grey.

### Combinations of floor and wall units:

If floor and wall units are combined within an arrangement, there must not be any skirting boards in the room near the floor units, otherwise they must be removed.

### Max. load:

Maximum load of wooden and glass shelves (up to 70.4 cm width) as well as drawers: 25 kg  
Maximum load of wooden and glass shelves (between 70.4 and 105.6 cm width): 15 kg;  
from 105.6 cm width: 10 kg  
Maximum load of cover shelves: 35 kg per metre length for floor units.  
Please also note any other data on maximum loads for individual units on the pages inside!

### hülsta-Push-to-open:

Drawers and flap units with hülsta Push-to-open. All drawers on hidden roller bearings as fully pull-out units.

## Labelling in type list drawings / assembly notes for wall units

### Labelling in type list drawings / assembly notes for wall units

The majority of units have two wall mounting points (= number of base plates), if these are to be fitted as wall units. This is not explicitly mentioned in the type list. If a different number of wall mounting points (= base plates) is required, this is marked in the drawings in the type list with numbers in black boxes. Please be sure to note here the information and notes in the "Wall composition" chapter!

3

4

## Notes on delivery

### Notes on delivery:

The majority of the units are delivered standard as **fully connected units (glued)** so that the carcass **cannot be disassembled**. There are however some **exceptions** to this rule:

Some carcasses are delivered as complete units but can be **disassembled into individual sections** in the final customer's home. These types are marked with a **1** in the type list.

Some carcasses are delivered **in individual sections** because of their size. These types are marked with a **2** in the type list.

The fronts with the number **2** are delivered separately and can therefore always be (dis-) assembled.

## Wall fitting

**Important notes:** Generally speaking, you as a dealer/qualified fitter are responsible for the correct wall mounting of the units. That is why wall mounting should only be carried out by properly trained and qualified fitters. hülsta supplies materials for mounting units on walls for nearly all the units and which should be used for safety and for constructional reasons. The assembly materials supplied by hülsta (plugs, screws) are only suitable for fitting components on to concrete in firmness class C12/15. For other materials (please see separate materials table in the wall composition chapter) we provide you with an assembly mortar set as an extra order. Please note that this assembly mortar set is also only suitable for the materials listed in the materials table. If walls are made up of other materials (e.g. plastered or lighter wall materials), one should use another method of mounting better suited to the load on site. Please note that if the units are not mounted properly on the wall, there is a risk of the units falling down or tipping over – especially when alternative mounting materials acquired on site have been used. For the reasons stated above it is absolutely essential to enquire about the composition of any walls before signing any contracts.



## Wardrobes

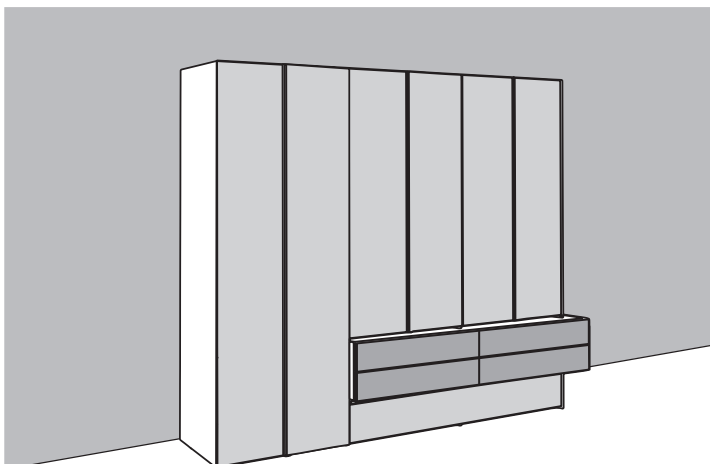

### Wardrobes

- Hinge-door wardrobes can be combined with folding-door wardrobes, design, intermediate and hinge-doors cloakroom units
- Front mirrors and lamps against surcharge
- Unit outside widths hinge-door wardrobes: 42, 52, 82, 102 cm (basic units)  
40, 50, 80, 100 cm (extension units)
- Unit outside widths folding-door wardrobes: 82, 102, 162, 202 cm (basic units)  
80, 100, 160, 200 cm (extension units)  
extra-wide panorama-units in 160/162 and 200/202 cm width without partition
- Unit outside widths design units: 179/180.6 and 214/215.6 cm
- Unit outside widths intermediate units: 80, 100 cm
- Unit outside widths hinge-doors cloakroom units: 160/162 and 210/212 cm resp. 129.2/131.2 and 179.2/181.2 cm
- Unit inside widths hinge-door wardrobes: 38, 48, 78, 98 cm
- Unit inside widths folding-door wardrobes: 78, 98, 158, 198 cm
- Unit inside widths hinge-doors cloakroom units: 48 and 98 cm
- Outside depth: 61.4 cm
- Inside depth: 56 cm
- Door opening angle: approx. 94°

## Bed unit

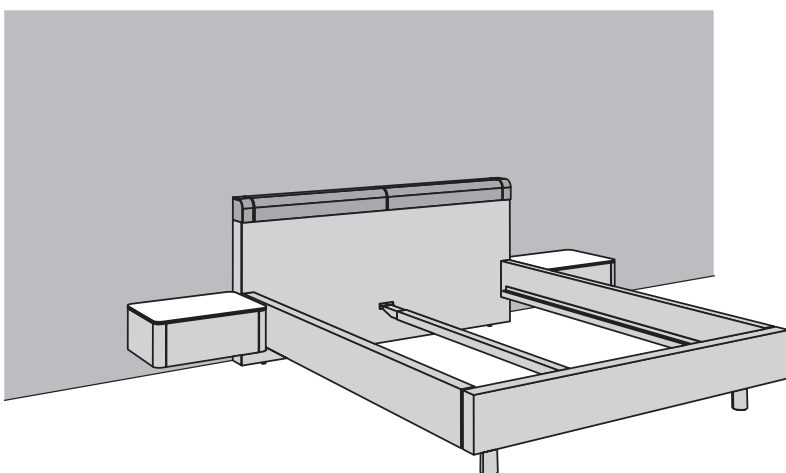

### Beds

- Beds with bed surround in wood/lacquer version or with upholstered application
- Beds with headboard in wood/lacquer version and upholstered application or with upholstered headboard
- Bed inside lengths: 200, 210, 220 cm
- Bed inside widths: 140, 160, 180, 200 cm
- Beds optionally in a hovering look

### Consoles

- Consoles with rounded end at both sides
- Floor console with 2 drawers in one width
- Wall console with 1 drawer in one width
- Optionally with functional frame and lamps

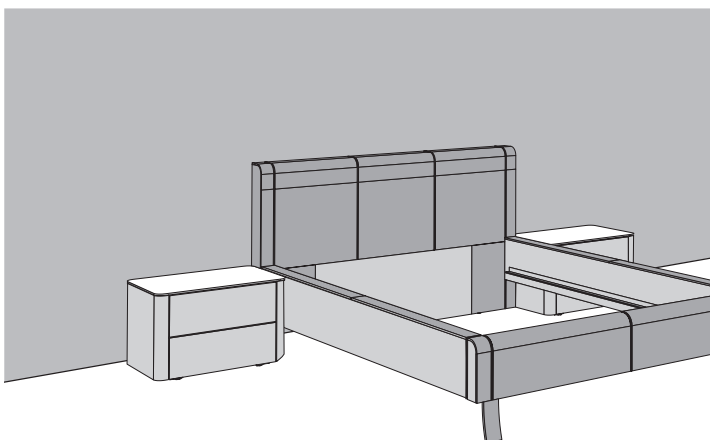

# Concept and possible arrangements

## Unit as floor unit, with wall bracket for wall assembly or on metal substructure

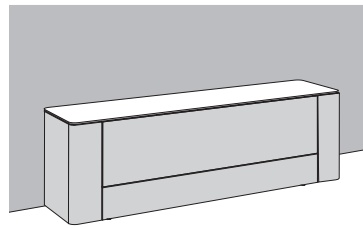
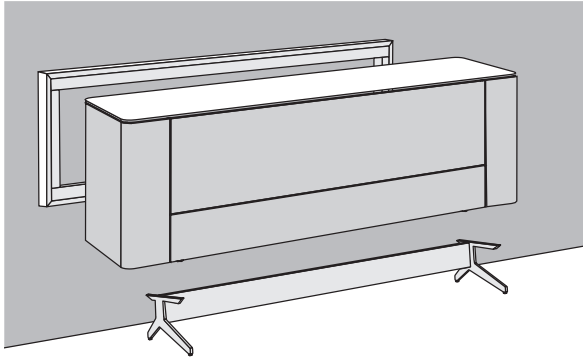

**Unit as floor unit**  
incl. 1.8 cm high plinth adjusters

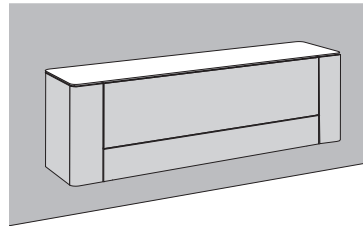

**Unit with wall bracket for wall assembly**  
If the unit is planned as a wall unit, a wall bracket must be ordered. In this case the plinth adjusters are omitted.

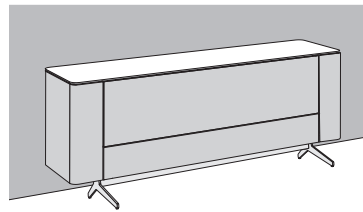

**Unit on metal substructure**  
The units can be planned optionally on a metal substructure (19.4 cm high). In this case the plinth adjusters are omitted.

## Notes on accent units, (wall) cabinets and wall shelf unit

Accent unit

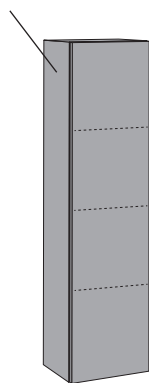

**Notes on accent units:**  
Carcase and front also in the versions knotted oak, knotted oak anthracite, knotted core walnut, Nappa leather and Nubuk-Touch leather possible (exception: accent unit of hinge-doors cloakroom units is not available in leather versions). The inside carcass of accent units in leather version is in matt grey lacquer. If accent units are required in a leather version, the unit width increases by 1.6 cm.

Accent

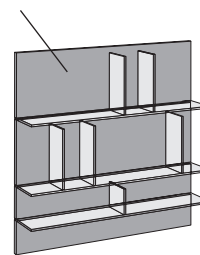

**Notes on wall shelf unit:**  
Shelves and partitions of bronzed glass; shelf rear wall of wall unit possible in all versions (exception: leather versions).

Accent

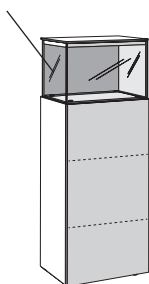

**Notes on cabinets:**  
Outer glass sides of cabinets and glass shelves behind fronts of bronzed glass; cabinet compartment rear wall possible in all versions (exception: leather versions).

**Functional frame**

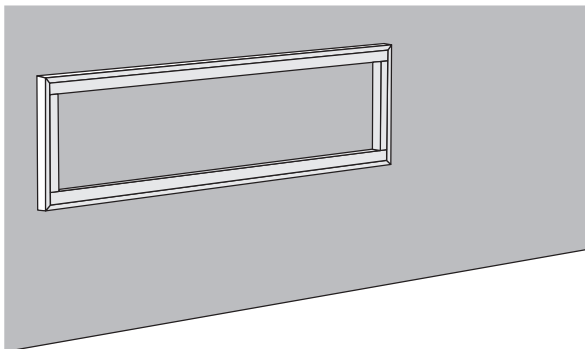

**Functional frame**

Functional frame for floor units of wood resp. for wall assembly of metal. Functional frame always in white lacquer.

The functional frame enables the following functions:

- Distance frame for a hovering look
- Inclusion of LED lamp
- Hiding cables

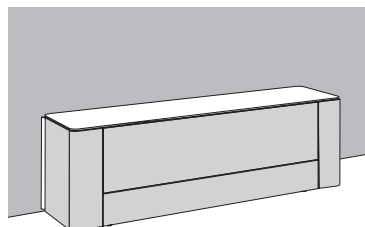

**Unit with functional frame for floor units**

The units can be planned optionally with a functional frame for floor units.

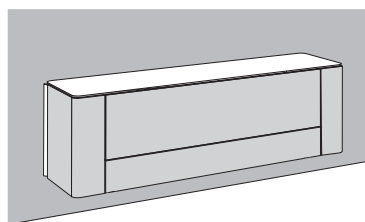

**Unit with functional frame for wall assembly**

If you plan a functional frame for wall assembly, you require an extra wall bracket. In this case the plinth adjusters are omitted.

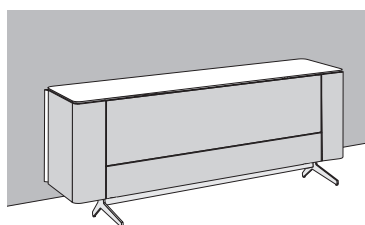

**Unit with functional frame on metal substructure**

The units with a functional frame can be planned optionally on a metal substructure (19.4 cm high). In this case the plinth adjusters are omitted.

**LED lamps for functional frame**

**LED lamps for functional frame**

The functional frame can be fitted with an optional LED lamp. LED lamp incl. footswitch. Lamp switch optionally with a remote control unit possible (against surcharge).

LED lamp of the functional frame for floor units:

3-sided lighting

LED lamp of the functional frame for wall assembly:

4-sided lighting

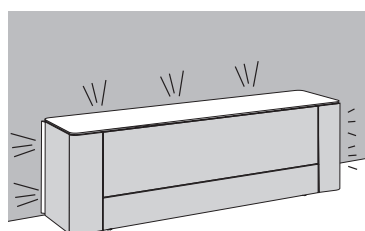

**3-sided lighting of functional frame for floor units**

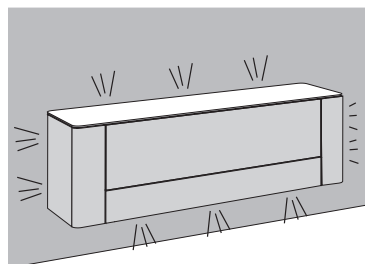

**4-sided lighting of functional frame for wall assembly**

**NEW**

**Drawer and hinge-door for end units**

**Drawer and hinge-door for end units**

The rounded end units of the low-, side- and highboards can optionally be fitted with drawers and/or hinge-doors.

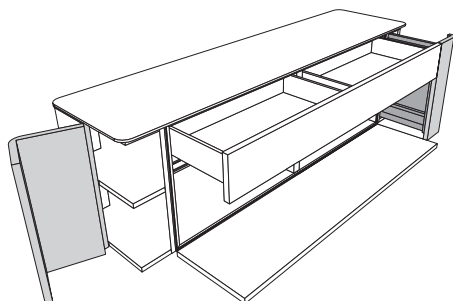

**Lowboard with end units with drawers**

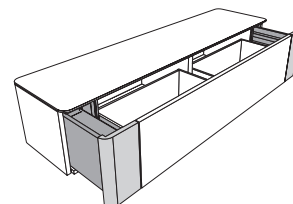

**Sideboard with end units with hinge-doors**

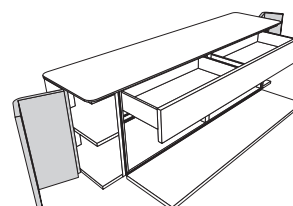



# Special combinations

Please also note the mattresses and base frames in the "Sleeping systems" type list!

Special combinations are arrangements that are reduced in price. This price advantage is only available when the arrangement is ordered exactly as described. The special combinations can be enhanced by including accessories. These are charged extra.

**Special combinations** consisting of **bed unit** (bed with bed surround in wood/lacquer version and two consoles) and a **hinge- or folding-door wardrobe**. The price of an entire special combination (bed unit and wardrobe) can be found in the boxes shaded grey!

**Special-sized products for special combinations are possible! Pricing:** special combination + 15% plus all the required special-sized products (see „Special-sized products“)!  
**Please note:** Height reductions of wardrobes remain free of charge!

**Important:** choose a bed with bed surround in wood/lacquer version (all bed sizes possible – please state type no.; see page 16), two consoles (all console types are possible – please state type no.; see page 19) as well as one of the wardrobes listed below.



Bed unit with wall consoles

or

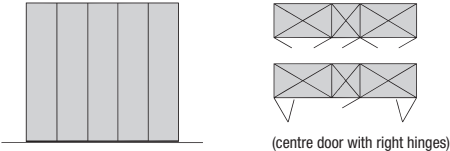
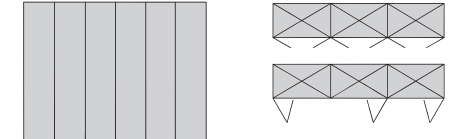
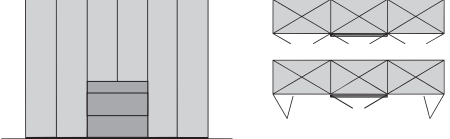
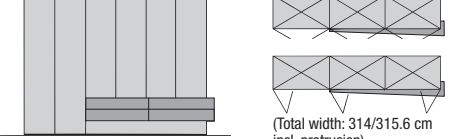

Bed unit with floor consoles

		Price of an entire special combination (bed unit and wardrobe)		Surcharge for wardrobe lamps
		with hinge-doors	with folding-doors	
<b>4-door hinge- or folding-door wardrobe</b> 202 cm wide 	Price gr. I II	<b>A8406</b> - -	<b>A8407</b> - -	For this wardrobe combination we recommend 2 top LED lamps. 2x <b>395</b> 2x -
<b>5-door hinge- or folding-door wardrobe</b> 252 cm wide  (centre door with right hinges)	Price gr. I II	<b>A8416</b> - -	<b>A8417</b> - -	Notes on the energy class: see page 9!
<b>6-door hinge- or folding-door wardrobe</b> 302 cm wide 	Price gr. I II	<b>A8436</b> - -	<b>A8437</b> - -	For this wardrobe combination we recommend 3 top LED lamps. 3x <b>395</b> 3x -
<b>6-door hinge- or folding-door wardrobe</b> 302 cm wide 	Price gr. I II	<b>A8426</b> - -	<b>A8427</b> - -	
<b>6-door hinge- or folding-door wardrobe</b> 302 cm wide  (Total width: 314/315.6 cm incl. protrusion)	as illustr. v. versa Price gr. I II	<b>A8446</b> <b>A8456</b> - -	<b>A8447</b> <b>A8457</b> - -	

## Additional fittings for special combinations / surcharges

<b>Bed in a hovering look</b> The special combination is delivered standard with a bed on legs. It is optionally available with a bed in a hovering look (without surcharge). <b>Please state clearly in the order!</b>	<b>Surcharge for upholstered headboard</b> The special combination is delivered standard with a bed with headboard in wood/lacquer version. It is optionally available with a bed with an upholstered headboard (against surcharge). <b>Please state clearly in the order!</b>	<b>Surcharge for bed surround with upholstered application</b> The special combination is delivered standard with a bed with bed surround in wood/lacquer version. It is optionally available with a bed with bed surround with upholstered application (against surcharge). <b>Please state clearly in the order!</b>
<b>3002</b> without surcharge	<b>3003</b> -	<b>3004</b> -

## Notes on planning hinge- and folding-door wardrobes according to the endless assembly principle

Hinge- and folding-door wardrobes can be planned endlessly and combined with one another. Due to the various element widths one can create many total wardrobe widths. In this way the available floor space can be exploited to the full. For each wardrobe combination, the first element on the left is considered to be the basic unit, incorporating both outer side-sections. One can only include one basic unit in each combination. When adding on extension units, the right-hand side-section of the basic unit is employed as the end side-section of the complete combination. In the case of single-door hinge-door units as well as folding-door wardrobes one can choose between left- and right-hand hinges.

The graphics shown below give you an excerpt from our wardrobe assortment. We suggest using design and intermediate units for creating an alternative look.

Standard interior fittings per unit: 2 fitted shelves, 1 clothes rod.  
All interior surfaces are in white lacquer.

## Dimensions

	Wardrobe height	Wardrobe height with top LED lamp
Heights incl. plinth:	229.6 cm	234.6 cm
	<b>Height reductions at intervals of 1.0 cm without surcharge</b>	
Depths:	61.4 cm	74.2 cm
Widths:	see pages 10-15	

## Wardrobe examples

### Hinge-door wardrobe

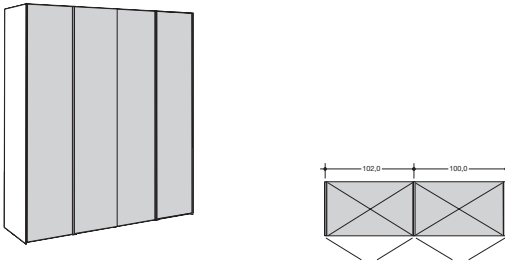

- Hinge-door wardrobes can be combined with folding-door wardrobes, design, intermediate and hinge-doors cloakroom units
- Front mirrors and lamps against surcharge
- Unit outside widths: 42, 52, 82, 102 cm (basic units)  
40, 50, 80, 100 cm (extension units)
- Unit inside widths: 38, 48, 78, 98 cm
- Outside depth: 61.4 cm
- Inside depth: 56 cm
- Door opening angle: approx. 94°

### Folding-door wardrobe

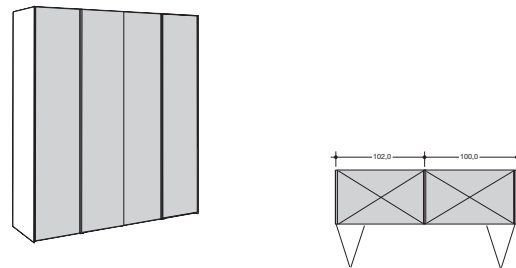

- Folding-door wardrobes can be combined with hinge-door wardrobes, design, intermediate and hinge-doors cloakroom units
- Extra-wide panorama units in 160/162 and 200/202 cm width, without partition
- Front mirrors and lamps against surcharge
- Unit outside widths: 82, 102, 162, 202 cm (basic units)  
80, 100, 160, 200 cm (extension units)
- Unit inside widths: 78, 98, 158, 198 cm
- Outside depth: 61.4 cm
- Inside depth: 56 cm
- Door opening angle: approx. 94°

### Hinge-door wardrobe with integrated intermediate unit

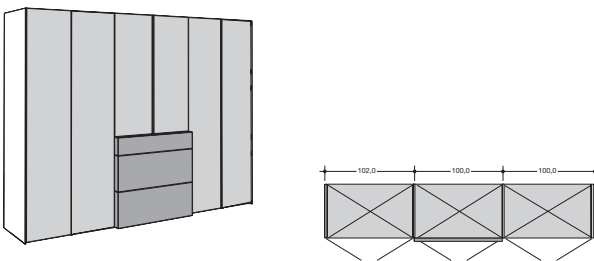

- Hinge-door wardrobes can be combined with folding-door wardrobes, design, intermediate and hinge-doors cloakroom units
- Design and intermediate units for a more open look
- Functional hinge-doors cloakroom units
- Front mirrors and lamps against surcharge
- Unit outside widths: 42, 52, 82, 102 cm (basic units)  
40, 50, 80, 100 cm (extension units)  
179/180.6 and 214/215.6 cm (design units)  
80, 100 cm (intermediate units)  
160/162 and 210/212 cm resp. 129.2/131.2 and 179.2/181.2 cm (hinge-doors cloakroom units)
- Unit inside widths: 38, 48, 78, 98 cm
- Outside depth: 61.4 cm
- Inside depth: 56 cm
- Door opening angle: approx. 94°

### Lamps

All hinge- and folding-door wardrobes are available with optional top LED lamps. One top LED lamp (12 V; 2.4 W) is fitted above each unit – 1-door or 2-door (exception panorama unit: two top LED lamps). If required, a top LED lamp can be fitted centrally above each door. Please include a sketch in all cases. Switching is done by an external footswitch. A remote control unit is also available as an alternative, which is charged extra. The remote control unit incorporates one transmitter and one receiver which operate all the LED lamps. The footswitch is omitted when the remote control unit is employed.

**Radio remote control with change of colour temperature**  
(transmitter + receiver)

**2119** -

**Top LED lamp**  
**Surcharge for each additional lamp (2.4 W)**  
type

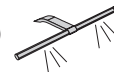



**395** -



This luminaire contains built-in LED lamps of the energy classes A++ to A. The lamps cannot be changed in the luminaire. 12 V

# Hinge-door wardrobes

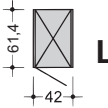
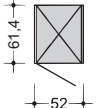
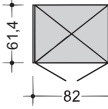
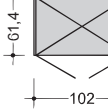
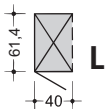
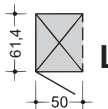
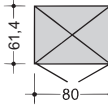
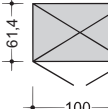
For each project please remember to leave a 2 cm gap to the ceiling and at the side for assembly!



<b>Hinge-door wardrobes</b> <b>Height: 229.6 cm</b> (height with top LED lamp: 234.6 cm); height reductions at intervals of 1.0 cm without surcharge <b>Width:</b> see table <b>Depth: 61.4 cm</b> (depth with top LED lamp: 74.2 cm) Interior fittings per unit: 2 fitted shelves, 1 clothes rod; interior fittings in standard <b>white lacquer</b> . Doors with handle slat in high-gloss chrome (standard) or in lacquer version.	<b>Doors</b> 	<b>Surcharge for top LED lamp</b> 1 lamp per unit  Notes on the energy class: see page 9!	<b>Surcharge for mirror</b> Each wardrobe door can be optionally fitted with a mirror (vertical facette) for which a surcharge is made. 
<b>Basic units</b> with 2 outer side-sections (each 2 cm thick) For each wardrobe combination, the first element on the left is considered to be the basic unit, incorporating both outer side-sections. One can only include one basic unit in each combination. When adding on extension units, the right-hand side-section is employed as the end side-section.		Please also note the functional and high-quality <b>wardrobe interior fittings</b> in the „Wardrobe interior fittings“ type list as well as the special articles and possible <b>special-sized products</b> .	
 Single-door unit, left or right, 42 cm wide	Price gr. I II	A02011 L A02012 R - -	
 Single-door unit, left or right, 52 cm wide	Price gr. I II	A2011 L A2012 R - -	
 Twin-door unit, 82 cm wide	Price gr. I II	A0202 - -	
 Twin-door unit, 102 cm wide	Price gr. I II	A202 - -	395 -
<b>Extension units</b> with 1 centre partition (2 cm thick)			
 Single-door unit, left or right, 40 cm wide	Price gr. I II	A00011 L A00012 R - -	
 Single-door unit, left or right, 50 cm wide	Price gr. I II	A0011 L A0012 R - -	
 Twin-door unit, 80 cm wide	Price gr. I II	A0002 - -	
 Twin-door unit, 100 cm wide	Price gr. I II	A002 - -	Please mark exactly in the front sketch or state in the order (from the left) which hinge-doors are to be fitted with a mirror.  <b>Surcharge for mirror per hinge-door:</b> -

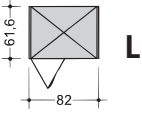
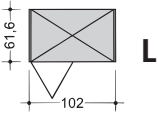
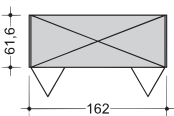
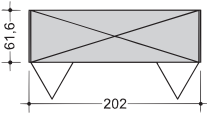
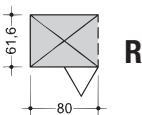
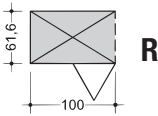
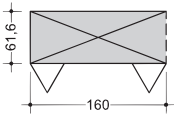
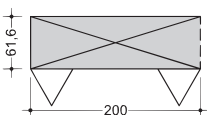



Folding-door wardrobes		Doors	Surcharge for top LED lamp	Surcharge for mirror
<p><b>Height: 229.6 cm</b> (height with top LED lamp: 234.6 cm); height reductions at intervals of 1.0 cm without surcharge</p> <p><b>Width:</b> see table</p> <p><b>Depth: 61.4 cm</b> (depth with top LED lamp: 74.2 cm)</p> <p>Interior fittings per unit: 2 fitted shelves, 1 clothes rod; interior fittings in standard <b>white lacquer</b>.</p> <p>Doors with handle slat in high-gloss chrome (standard) or in lacquer version.</p>			<p>1 lamp per unit</p>  <p>Notes on the energy class: see page 9!</p>	<p>Each wardrobe door can be optionally fitted with a mirror (vertical facette) for which a surcharge is made.</p> 
<p><b>Basic units</b> with 2 outer side-sections (each 2 cm thick)</p> <p>For each wardrobe combination, the first element on the left is considered to be the basic unit, incorporating both outer side-sections. One can only include one basic unit in each combination. When adding on extension units, the right-hand side-section is employed as the end side-section.</p>		<p>Please also note the functional and high-quality <b>wardrobe interior fittings</b> in the „Wardrobe interior fittings“ type list as well as the special articles and possible <b>special-sized products</b>.</p>		
 <p>Twin-door unit, left or right, 82 cm wide</p>	<p>Price gr.</p> <p>I</p> <p>II</p>	<p><b>A2221 L</b> <b>A2222 R</b></p> <p>-</p> <p>-</p>		
 <p>Twin door unit, left or right, 102 cm wide</p>	<p>Price gr.</p> <p>I</p> <p>II</p>	<p><b>A2321 L</b> <b>A2322 R</b></p> <p>-</p> <p>-</p>	<p><b>395</b></p> <p>-</p>	
 <p>Panorama unit 4-door, 162 cm wide - without partition</p>	<p>Price gr.</p> <p>I</p> <p>II</p>	<p><b>A2420</b></p> <p>-</p> <p>-</p>	<p>For this wardrobe combination we recommend 2 top LED lamps.</p>	<p>Please mark exactly in the front sketch or state in the order (from the left) which folding-door wings are to be fitted with a mirror.</p>
 <p>Panorama unit 4-door, 202 cm wide - without partition</p>	<p>Price gr.</p> <p>I</p> <p>II</p>	<p><b>A2520</b></p> <p>-</p> <p>-</p>	<p>2x <b>395</b></p> <p>2x -</p>	<p><b>Surcharge for mirror per folding-door wing:</b></p> <p>-</p>
<p><b>Extension units</b> with 1 centre partition (2 cm thick)</p>				
 <p>Twin-door unit, left or right, 80 cm wide</p>	<p>Price gr.</p> <p>I</p> <p>II</p>	<p><b>A0221 L</b> <b>A0222 R</b></p> <p>-</p> <p>-</p>		
 <p>Twin door unit, left or right, 100 cm wide</p>	<p>Price gr.</p> <p>I</p> <p>II</p>	<p><b>A0321 L</b> <b>A0322 R</b></p> <p>-</p> <p>-</p>	<p><b>395</b></p> <p>-</p>	
 <p>Panorama unit 4-door, 160 cm wide - without partition</p>	<p>Price gr.</p> <p>I</p> <p>II</p>	<p><b>A0420</b></p> <p>-</p> <p>-</p>	<p>For this wardrobe combination we recommend 2 top LED lamps.</p>	
 <p>Panorama unit 4-door, 200 cm wide - without partition</p>	<p>Price gr.</p> <p>I</p> <p>II</p>	<p><b>A0520</b></p> <p>-</p> <p>-</p>	<p>2x <b>395</b></p> <p>2x -</p>	

# Design units

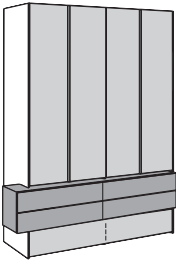
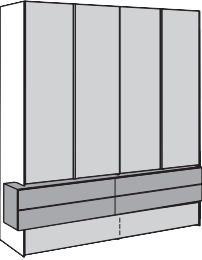
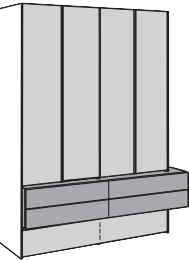
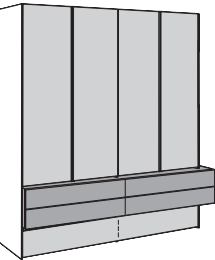
For each project please remember to leave a 2 cm gap to the ceiling and at the side for assembly!

Design units		Doors		Surcharge for top LED lamp	Lamps for design unit (above the accent drawers)	
<p><b>Height: 229.6 cm</b> (height with top LED lamp: 234.6 cm); height reductions (possible to a total height of 201 cm) at intervals of 1.0 cm without surcharge.  <b>Width:</b> see table (width reductions not possible)  <b>Depth: 61.4 cm</b> (depth with top LED lamp: 74.2 cm; depth reductions are not possible)  <b>Total depth: 74.6 cm</b> incl. protrusion; with drawers in leather version: 76.2 cm incl. protrusion</p> <p>Interior fittings per unit: see below; interior fittings always in <b>white lacquer</b>.</p> <p>Doors with handle slat in high-gloss chrome (standard) or in lacquer version.</p>				<p>1 lamp per unit</p> 	<p>This luminaire contains built-in LED lamps of the energy classes A++ to A. The lamps cannot be changed in the luminaire. 12 V</p>	
<p><b>Design basic units with 2 outer side sections (each 2 cm thick)</b></p> <p>For each wardrobe combination, the first element on the left is considered to be the basic unit, incorporating both outer side-sections. One can only include one basic unit in each combination. When adding on extension units, the right-hand side-section is employed as the end side-section.</p>		with hinge-doors	with folding-doors			
	<p><b>Basic design unit</b></p> <p>Top: 4 hinge- or folding-doors; interior fittings: 4 fitted shelves, 2 clothes rods</p> <p>Middle: 4 drawers in <b>accent version</b> with hülsta-Push-to-open</p> <p>Bottom: 1 drawer with handle, split drawer frame and hülsta-SoftFlow</p> <p>162 cm wide; total width: 179 cm incl. protrusion; with drawers in leather version: 180.6 cm incl. protrusion</p>	<p>Price gr. I - II -</p>	<p><b>A2701</b></p> <p style="text-align: center;">-</p>	<p><b>A2711</b></p> <p style="text-align: center;">-</p>	<p>For this wardrobe combination we recommend 2 top LED lamps.</p> <p>2x <b>395</b></p> <p>2x -</p>	<p>6.5 W</p> <p><b>2010</b></p> <p style="text-align: center;">-</p>
	<p><b>Basic design unit</b></p> <p>Top: 4 hinge- or folding-doors; interior fittings: 4 fitted shelves, 2 clothes rods</p> <p>Middle: 4 drawers in <b>accent version</b> with hülsta-Push-to-open</p> <p>Bottom: 1 drawer with handle, split drawer frame and hülsta-SoftFlow</p> <p>202 cm wide; total width: 214 cm incl. protrusion; with drawers in leather version: 215.6 cm incl. protrusion</p>	<p>Price gr. I - II -</p>	<p><b>A2801</b></p> <p style="text-align: center;">-</p>	<p><b>A2811</b></p> <p style="text-align: center;">-</p>		<p>8.0 W</p> <p><b>2020</b></p> <p style="text-align: center;">-</p>
<p><b>Design extension units with 1 partition (2 cm thick)</b></p>						
	<p><b>Design extension unit</b></p> <p>Top: 4 hinge- or folding-doors; interior fittings: 4 fitted shelves, 2 clothes rods</p> <p>Middle: 4 drawers in <b>accent version</b> with hülsta-Push-to-open</p> <p>Bottom: 1 drawer with handle, split drawer frame and hülsta-SoftFlow</p> <p>160 cm wide; total width: 179 cm incl. protrusion; with drawers in leather version: 180.6 cm incl. protrusion</p>	<p>Price gr. I - II -</p>	<p><b>A0702</b></p> <p style="text-align: center;">-</p>	<p><b>A0712</b></p> <p style="text-align: center;">-</p>	<p>For this wardrobe combination we recommend 2 top LED lamps.</p> <p>2x <b>395</b></p> <p>2x -</p>	<p>6.5 W</p> <p><b>2010</b></p> <p style="text-align: center;">-</p>
	<p><b>Design extension unit</b></p> <p>Top: 4 hinge- or folding-doors; interior fittings: 4 fitted shelves, 2 clothes rods</p> <p>Middle: 4 drawers in <b>accent version</b> with hülsta-Push-to-open</p> <p>Bottom: 1 drawer with handle, split drawer frame and hülsta-SoftFlow</p> <p>200 cm wide; total width: 214 cm incl. protrusion; with drawers in leather version: 215.6 cm incl. protrusion</p>	<p>Price gr. I - II -</p>	<p><b>A0802</b></p> <p style="text-align: center;">-</p>	<p><b>A0812</b></p> <p style="text-align: center;">-</p>		<p>8.0 W</p> <p><b>2020</b></p> <p style="text-align: center;">-</p>

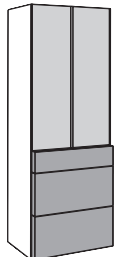
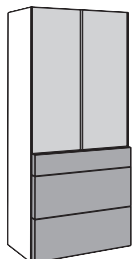
<b>Intermediate units 1 and 2</b> <b>Height: 229.6 cm</b> (height with top LED lamp: 234.6 cm); height reductions (possible to a total height of 201 cm) at intervals of 1.0 cm without surcharge. <b>Width:</b> see table (width reductions are not possible) <b>Depth: 61.4 cm</b> (depth with top LED lamp: 74.2 cm; depth reductions are not possible) <b>Total depth: 67.1 cm</b> incl. protrusion  Intermediate units 1 and 2 are also possible on request as basic and end units or stand-alone units. Two intermediate units can also be placed adjacently to one another.  Interior fittings per unit: see below; interior fittings in standard <b>white lacquer</b> . Doors with handle slat in high-gloss chrome (standard) or in lacquer version.		<b>Doors</b>  	<b>Surcharge for top LED lamp</b>  1 lamp per unit    Notes on the energy class: see page 9!
<b>Intermediate units 1 and 2</b>		<b>with hinge-doors</b>	
 80 cm wide	<b>Intermediate unit 1</b>  Top: 2 hinge-doors with 2 fitted shelves; inside width: 78 cm; inside depth: 56.5 cm  Bottom: 3 drawers in <b>accent version</b> with hüsta-Push-to-open; inside depth: 48.5 cm	<b>A0900</b>  Price gr. I - II -	<b>395</b>  -
 100 cm wide	<b>Intermediate unit 2</b>  Top: 2 hinge-doors with 2 fitted shelves; inside width: 98 cm; inside depth: 56.5 cm  Bottom: 3 drawers in <b>accent version</b> with hüsta-Push-to-open; inside depth: 48.5 cm	<b>A0910</b>  Price gr. I - II -	

## Interior TV unit fittings for intermediate units 1 and 2



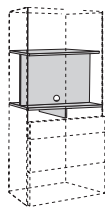
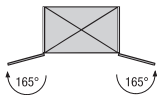
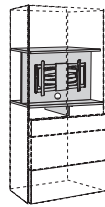
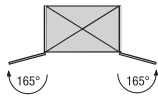

Please observe the space requirements given by the electrical dealer (heat build-up)!





<b>Interior TV unit fitting A for intermediate units 1 and 2</b> TV compartment including cable aperture in TV panel (usable inside dims.: 68.1 cm high, 78.0 (or 98.0) cm wide, 35.5 cm deep; max. load: 60 kg); 2 open compartments below for electronic equipment (usable inside dims. per compartment: 10.0 cm high, 38.0 (or 48.0) cm wide, 47.0 cm deep)  <b>Please note:</b> <ul style="list-style-type: none"> <li>When interior TV unit fittings are included, the doors of the intermediate units are fitted with 165° hinges ex-works.</li> <li>The 2 fitted shelves, which are fitted standard in the intermediate unit behind doors, are omitted and the price has already been deducted.</li> <li>Because of the 165° hinges on the intermediate unit including the interior TV unit fittings, the door hinges of any 1-door wardrobe units included which are situated directly next to the intermediate unit must be fitted on the side next to this intermediate unit!</li> </ul>	  	<b>Surcharge for interior TV unit fitting A</b>
	for 80 cm wide intermediate unit	<b>79601</b> -
	for 100 cm wide intermediate unit	<b>79611</b> -
<b>Interior TV unit fitting B for intermediate units 1 and 2</b> TV compartment including cable aperture in TV panel (usable inside dims.: 68.1 cm high, 78.0 (or 98.0) cm wide, 35.5 cm deep; max. load: 60 kg) and with flat screen support; 2 open compartments below for electronic equipment (usable inside dims. per compartment: 10.0 cm high, 38.0 (or 48.0) cm wide, 47.0 cm deep). The flat screen support can be adjusted 3-dimensionally. It is suitable for flat screens with a screen diagonal of 102-216 cm (40"-85"; please observe the usable dims. of the TV compartment; see above); max. load: 45 kg. Flat screen support compatible with VESA Norm standard: min.: 200 x 200 mm, max.: 600 x 400 mm  <b>Please note:</b> <ul style="list-style-type: none"> <li>When interior TV unit fittings are included, the doors of the intermediate units are fitted with 165° hinges ex-works.</li> <li>The 2 fitted shelves, which are fitted standard in the intermediate unit behind doors, are omitted and the price has already been deducted.</li> <li>Because of the 165° hinges on the intermediate unit including the interior TV unit fittings, the door hinges of any 1-door wardrobe units included which are situated directly next to the intermediate unit must be fitted on the side next to this intermediate unit!</li> </ul>	  	<b>Surcharge for interior TV unit fitting B</b>
	for 80 cm wide intermediate unit	<b>79602</b> -
	for 100 cm wide intermediate unit	<b>79612</b> -

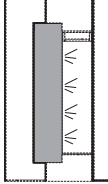

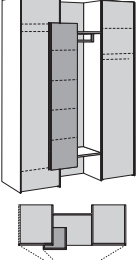
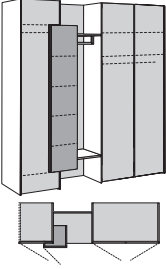
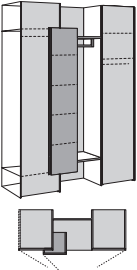
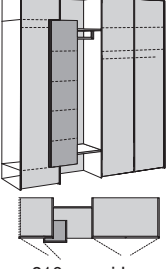
# Hinge-doors cloakroom units

For each project please remember to leave a 2 cm gap to the ceiling and at the side for assembly!

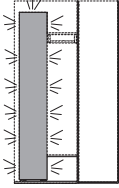
Hinge-doors cloakroom units		Doors	Surcharge for top LED lamp on hinge-door unit	Surcharge for indirect LED compartment lamps behind accent unit	Surcharge for mirror
<p><b>Height: 229.6 cm</b>  <b>Width: see table</b>  <b>Depth hinge-doors units: 61.4 cm</b>  <b>Total depth incl. protruding accent unit: 67.5 cm</b></p> <p>Height, width and depth reductions are not possible.</p> <p><b>Hinge-doors units (left and right):</b>                      Hinge-doors units 52/50 resp. 100/102 cm wide; hinge-doors with handle slat in high-gloss chrome (standard) or in lacquer version. Interior fittings hinge-doors units: 2 fitted shelves, 1 clothes rod; interior fittings always in <b>white lacquer</b>.</p> <p><b>Accent unit and open section:</b>                      Protruding accent unit 176.0 cm high, 35.2 cm wide, 33.0 cm deep; door of accent unit with hülsta-Push-to-open. Interior fitting accent unit: 4 fitted shelves in <b>accent version</b>. Open section with full-length rear wall and 2 fitted shelves in <b>lacquer version</b> (matt) and 1 clothes rod.</p>			<p>1 lamp per unit 2.4 W</p> 	<p>1 lamp per unit 12 W</p> 	<p>Each wardrobe door can be optionally fitted with a mirror (vertical facette) for which a surcharge is made.</p> 
<p><b>Hinge-doors cloakroom basic units with 2 outer side sections (each 2 cm thick)</b></p> <p>For each wardrobe combination, the first element on the left is considered to be the basic unit, incorporating both outer side-sections. One can only include one basic unit in each combination. When adding on extension units, the right-hand side-section is employed as the end side-section.</p>		<b>with hinge-doors</b>			
 <p><b>Hinge-doors cloakroom basic unit</b></p> <p>left: hinge-door unit middle: accent unit and open section right: hinge-door unit</p> <p>162 cm wide</p>	<p>as illustr. v. versa</p> <p><b>A2911</b> <b>A2912</b></p> <p>Price gr. I - II -</p>		<p>For this wardrobe combination we recommend 2 top LED lamps.</p>		<p>Please mark exactly in the front sketch or state in the order (from the left) which hinge-doors are to be fitted with a mirror.</p>
 <p><b>Hinge-doors cloakroom basic unit</b></p> <p>left: hinge-door unit middle: accent unit and open section right: hinge-doors unit</p> <p>212 cm wide</p>	<p>as illustr. v. versa</p> <p><b>A3111</b> <b>A3112</b></p> <p>Price gr. I - II -</p>		<p>2x 395</p> <p>2x -</p>	<p><b>2030</b></p> <p>-</p>	<p><b>Surcharge for mirror per hinge-door:</b></p> <p>-</p>
<p><b>Hinge-doors cloakroom extension units with 1 partition (2 cm thick)</b></p>					
 <p><b>Hinge-doors cloakroom extension unit</b></p> <p>left: hinge-door unit middle: accent unit and open section right: hinge-door unit</p> <p>160 cm wide</p>	<p>as illustr. v. versa</p> <p><b>A0911</b> <b>A0912</b></p> <p>Price gr. I - II -</p>				
 <p><b>Hinge-doors cloakroom extension unit</b></p> <p>left: hinge-door unit middle: accent unit and open section right: hinge-doors unit</p> <p>210 cm wide</p>	<p>as illustr. v. versa</p> <p><b>A0111</b> <b>A0112</b></p> <p>Price gr. I - II -</p>				

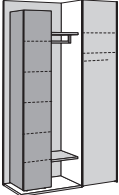
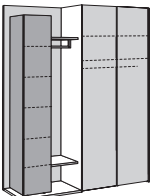
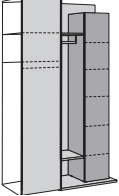
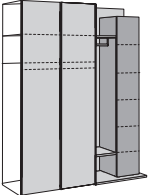
<p><b>Hinge-doors cloakroom units</b></p> <p><b>Total height: 229.6 cm</b>  <b>Width: see table</b>  <b>Total depth: 61.4 cm</b></p> <p>Height, width and depth reductions are not possible.</p> <p><b>Accent unit and open section:</b>                      Accent unit 211.2 cm high, 35.2 cm wide, 45.0 cm deep; door of accent unit with hüsta-Push-to-open. Interior fittings accent unit: 5 fitted shelves in <b>accent version</b>. Open section with full-length rear wall and 2 fitted shelves in <b>lacquer version</b> (matt) and 1 clothes rod.</p> <p><b>Hinge-doors units:</b>                      Hinge-doors unit 50 resp. 100 cm wide; hinge-doors with handle slat in high-gloss chrome (standard) or in lacquer version. Interior fittings hinge-doors units: 2 fitted shelves, 1 clothes rod; interior fittings in standard <b>white lacquer</b>.</p>	<p><b>Doors</b></p> 	<p><b>Surcharge for top LED lamp on hinge-door unit</b></p> <p>1 lamp per unit 2.4 W</p> 	<p><b>Surcharge for indirect LED compartment lamps behind accent unit</b></p> <p>1 lamp per unit 28.5 W</p> 	<p><b>Surcharge for mirror</b></p> <p>Each wardrobe door can be optionally fitted with a mirror (vertical facette) for which a surcharge is made.</p> 	
<p><b>Hinge-doors cloakroom basic units with 2 outer side sections (each 2 cm thick)</b></p> <p>For each wardrobe combination, the first element on the left is considered to be the basic unit, incorporating both outer side-sections. One can only include one basic unit in each combination. When adding on extension units, the right-hand side-section is employed as the end side-section.</p>	<p><b>with hinge-doors</b></p>				
 <p><b>Hinge-doors cloakroom basic unit</b></p> <p>left: accent unit and open section right: hinge-door unit</p> <p>131.2 cm wide</p>	<p>as illustr. v. versa</p> <p>Price gr. I - II -</p>	<p><b>A3311</b> <b>A3312</b></p>			<p>Please mark exactly in the front sketch or state in the order (from the left) which hinge-doors are to be fitted with a mirror.</p>
 <p><b>Hinge-doors cloakroom basic unit</b></p> <p>left: accent unit and open section right: hinge-doors unit</p> <p>181.2 cm wide</p>	<p>as illustr. v. versa</p> <p>Price gr. I - II -</p>	<p><b>A3411</b> <b>A3412</b></p>	<p><b>395</b></p>	<p><b>12340</b></p>	<p><b>Surcharge for mirror per hinge-door:</b></p>
<p><b>Hinge-doors cloakroom extension units with 1 partition (2 cm thick)</b></p>					
 <p><b>Hinge-doors cloakroom extension unit</b></p> <p>left: hinge-door unit right: accent unit and open section</p> <p>129.2 cm wide</p>	<p>Price gr. I - II -</p>	<p><b>A0312</b></p>			
 <p><b>Hinge-doors cloakroom extension unit</b></p> <p>left: hinge-doors unit right: accent unit and open section</p> <p>179.2 cm wide</p>	<p>Price gr. I - II -</p>	<p><b>A0412</b></p>			

## Beds with bed surround in wood/lacquer version

Please also note the mattresses and base frames in the "Sleeping systems" type list!

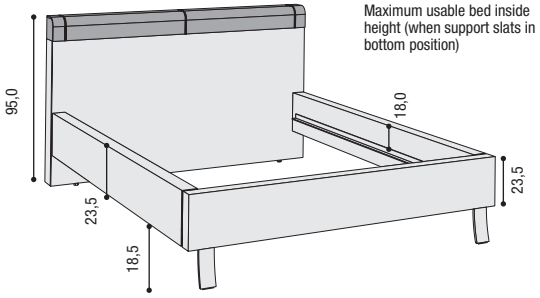
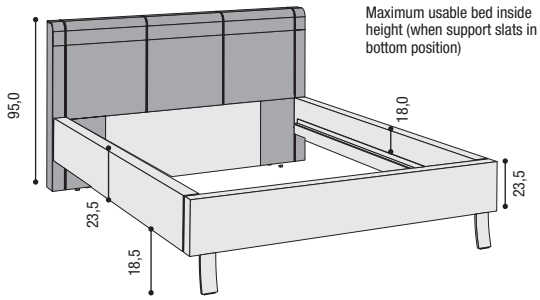
<b>Beds with headboard in wood/lacquer version and upholstered application and bed surround in wood/lacquer version; upholstered application in leather</b> Beds incl. support slats for base frames and mattresses • Adjustable in height by 3.2 cm downwards and upwards • Usable bed inside height: max. 18.0 cm  <b>Please state all the versions clearly in the order!</b>  Beds are not available in high-gloss lacquer versions!  <b>Bed in a hovering look</b> The bed is also available in a hovering look (without surcharge). See here page 18!	Inside dims.	Outside dims.	Type no.	Price group I	Price group III
	140x200 160x200 180x200 200x200	156x219 176x219 196x219 216x219	725 726 727 728	- - - -	- - - -
 <p>Shaded dark grey = upholstered application</p>	140x210 160x210 180x210 200x210	156x229 176x229 196x229 216x229	735 736 737 738	- - - -	- - - -
	140x220 160x220 180x220 200x220	156x239 176x239 196x239 216x239	745 746 747 748	- - - -	- - - -
<b>Beds with upholstered headboard and bed surround in wood/lacquer version; upholstered headboard in leather</b> Beds incl. support slats for base frames and mattresses • Adjustable in height by 3.2 cm downwards and upwards • Usable bed inside height: max. 18.0 cm  <b>Please state all the versions clearly in the order!</b>  Beds are not available in high-gloss lacquer versions!  <b>Bed in a hovering look</b> The bed is also available in a hovering look (without surcharge). See here page 18!	Inside dims.	Outside dims.	Type no.	Price group I	Price group III
	140x200 160x200 180x200 200x200	156x219 176x219 196x219 216x219	7254 7264 7274 7284	- - - -	- - - -
 <p>Shaded dark grey = upholstered headboard</p>	140x210 160x210 180x210 200x210	156x229 176x229 196x229 216x229	7354 7364 7374 7384	- - - -	- - - -
	140x220 160x220 180x220 200x220	156x239 176x239 196x239 216x239	7454 7464 7474 7484	- - - -	- - - -

# Beds with bed surround with upholstered application

Bed accessories: see next page!

**GENTIS**

Please also note the mattresses and base frames in the "Sleeping systems" type list!

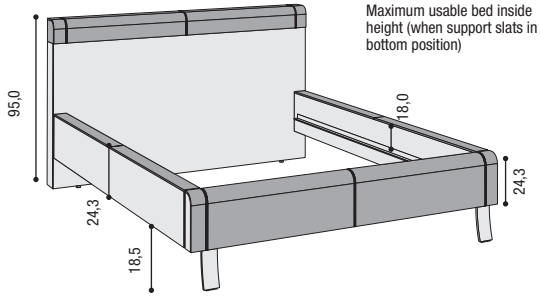
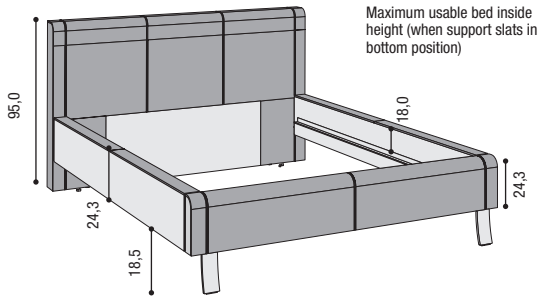
<b>Beds with headboard in wood/lacquer version and upholstered application and bed surround with upholstered application; upholstered applications in leather</b> Beds incl. support slats for base frames and mattresses • Adjustable in height by 3.2 cm downwards and upwards • Usable bed inside height: max. 18.0 cm  <b>Please state all the versions clearly in the order!</b>  Beds are not available in high-gloss lacquer versions!  <b>Bed in a hovering look</b> The bed is also available in a hovering look (without surcharge). See here page 18!	Inside dims.	Outside dims.	Type no.	Price group I	Price group III
 <p>Shaded dark grey = upholstered applications</p>	140x200 160x200 180x200 200x200	156x219 176x219 196x219 216x219	425 426 427 428	- - - -	- - - -
	140x210 160x210 180x210 200x210	156x229 176x229 196x229 216x229	435 436 437 438	- - - -	- - - -
	140x220 160x220 180x220 200x220	156x239 176x239 196x239 216x239	445 446 447 448	- - - -	- - - -
	<b>Beds with upholstered headboard and bed surround with upholstered application; upholstered headboard and applications in leather</b> Beds incl. support slats for base frames and mattresses • Adjustable in height by 3.2 cm downwards and upwards • Usable bed inside height: max. 18.0 cm  <b>Please state all the versions clearly in the order!</b>  Beds are not available in high-gloss lacquer versions!  <b>Bed in a hovering look</b> The bed is also available in a hovering look (without surcharge). See here page 18!	Inside dims.	Outside dims.	Type no.	Price group I
 <p>Shaded dark grey = upholstered headboard and applications</p>	140x200 160x200 180x200 200x200	156x219 176x219 196x219 216x219	4254 4264 4274 4284	- - - -	- - - -
	140x210 160x210 180x210 200x210	156x229 176x229 196x229 216x229	4354 4364 4374 4384	- - - -	- - - -
	140x220 160x220 180x220 200x220	156x239 176x239 196x239 216x239	4454 4464 4474 4484	- - - -	- - - -

## Bed accessories

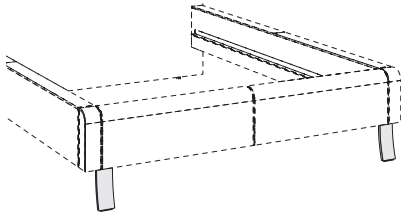
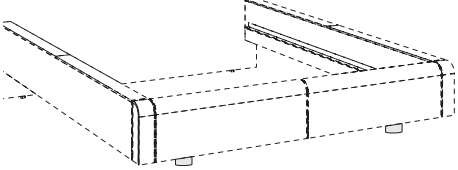
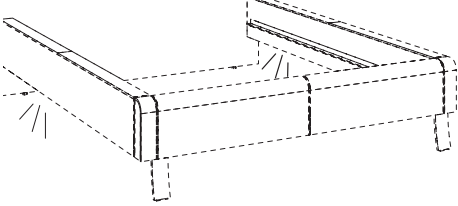

<p><b>Bed in a hovering look</b> The bed is delivered standard on high-gloss chrome legs. It is optionally available in a hovering look (without surcharge).</p> <p><b>Please state clearly in the order!</b></p>	<p>Bed on legs (standard)</p> 	<p>Bed in a hovering look</p>  <p><b>Bed in a hovering look</b></p> <p><b>3002</b> without surcharge</p>
<p><b>LED bedside lamp (pair)</b> with motion sensor for switching on and off (no time interval)</p> <p>This luminaire contains built-in LED lamps of the energy classes A++ to A. The lamps cannot be changed in the luminaire. 12 V</p>		<p>1.8 W</p> <p><b>LED bedside lamp</b></p> <p><b>894</b> -</p>

# Consoles

## with rounded end at both sides



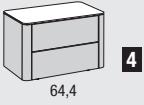

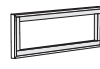
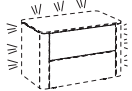
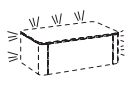





Assembly notes for wall units:  
Please be sure to note here the information  
and notes in the "Wall composition" chapter!



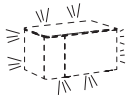
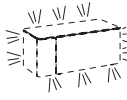
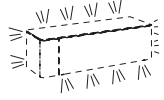

**GENTIS**

<p><b>Floor console with rounded end at both sides</b> 40.2 cm high (42.0 cm high incl. 1.8 cm high plinth adjusters), 45.0 cm deep</p> <p><b>Wall console with rounded end at both sides</b> 23.5 cm high 45.0 cm deep</p> <p><b>Wall units or wall assembly:</b> Please see here the information on page 4.</p>			Floor console	Wall console
				 <p>64.4 cm wide 2 drawers</p>
			<b>5023</b>	<b>5002</b>
	Price gr.	I	-	-
	II		-	-
<p><b>Functional frame for floor units</b> The units can be planned optionally with a functional frame for floor units.</p> <p><b>Functional frame for wall assembly</b> If you plan a functional frame for wall assembly for the consoles, you <b>do not</b> require an extra wall bracket.</p> <p>Max. load: 10 kg</p> <p>Please note the further information on functional frames on page 7.</p>				
			Functional frame for floor units	Functional frame for wall assembly
			<b>242</b>	<b>143</b>
<p><b>Lamp for functional frame</b> The functional frame can be fitted with an optional LED lamp. LED lamp incl. footswitch. Lamp switch optionally with a remote control unit (against surcharge; see page 38). Later fitting not possible.</p> <p>This luminaire contains built-in LED lamps of the energy classes A++ to A. The lamps cannot be changed in the luminaire. 12 V</p>			9.0 W	7.0 W
				
			<b>244</b>	<b>144</b>
			-	-



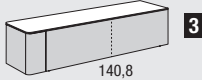
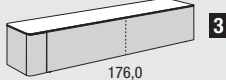

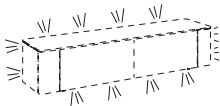
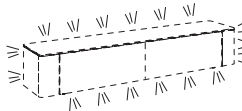





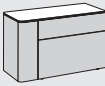
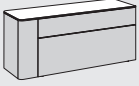
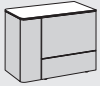
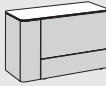
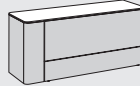





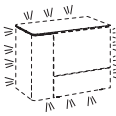
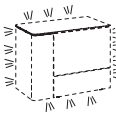
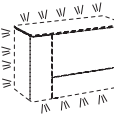
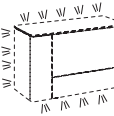
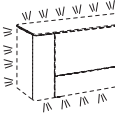
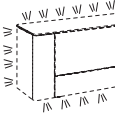

## 2 Raster lowboards with rounded end at one side

2 Raster lowboards with rounded end at one side 36.2 cm high (38.0 cm high incl. 1.8 cm high plinth adjusters), 45.0 cm deep  incl. cable aperture at centre of rear wall behind flap per compartment  <b>Wall units or wall assembly:</b> Please see here the information on page 4	2 Raster lowboards with rounded end at one side					
	 52,8 70.4 cm wide		 70,4 88.0 cm wide		 105,6 123.2 cm wide	
Flap hinge at bottom	1 drawer	1 flap	1 drawer	1 flap	1 drawer	1 flap
as illustr. v. versa	<b>27111</b> <b>27112</b>	<b>27181</b> <b>27182</b>	<b>28111</b> <b>28112</b>	<b>28181</b> <b>28182</b>	<b>212111</b> <b>212112</b>	<b>212181</b> <b>212182</b>
Price gr. I II	- -	- -	- -	- -	- -	- -
<b>Drawer for end unit</b> left (L; as illustr.) or right (R; vice versa)	<b>291L</b>	<b>292R</b>	<b>291L</b>	<b>292R</b>	<b>291L</b>	<b>292R</b>
	-	-	-	-	-	-
<b>Hinge-door for end unit</b> left (L; as illustr.) or right (R; vice versa)	<b>281L</b>	<b>282R</b>	<b>281L</b>	<b>282R</b>	<b>281L</b>	<b>282R</b>
	-	-	-	-	-	-
<b>Wall bracket</b> If units are planned as wall units, a wall bracket must be ordered.  Max. load: 40 kg	<b>255</b>		<b>275</b>		<b>2105</b>	
	-		-		-	
<b>Functional frame for floor units</b> The units can be planned optionally with a functional frame for floor units.  <b>Functional frame for wall assembly</b> If you plan a functional frame for wall assembly, you require an extra wall bracket. In this case the plinth adjusters are omitted.  Max. load: 40 kg  Please note the further information on functional frames on page 7.						
	Functional frame for floor units	Functional frame for wall assembly	Functional frame for floor units	Functional frame for wall assembly	Functional frame for floor units	Functional frame for wall assembly
	<b>252</b>	<b>253</b>	<b>272</b>	<b>273</b>	<b>2102</b>	<b>2103</b>
	-	-	-	-	-	-
<b>Lamp for functional frame</b> The functional frame can be fitted with an optional LED lamp. LED lamp incl. footswitch. Lamp switch optionally with a remote control unit (against surcharge; see page 38). Later fitting not possible.  This luminaire contains built-in LED lamps of the energy classes A++ to A. The lamps cannot be changed in the luminaire. 12 V	8.0 W	12.0 W	9.5 W	15.5 W	12.5 W	21.0 W
						
	<b>254</b>		<b>274</b>		<b>2104</b>	
	-		-		-	
<b>Metal substructure</b> 19.4 cm high; High-gloss chrome  The units can be planned optionally on a metal substructure. In this case the plinth adjusters are omitted.						
	<b>251</b>		<b>271</b>		<b>2101</b>	
	-		-		-	

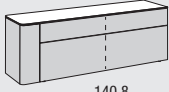

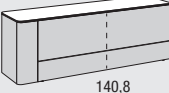
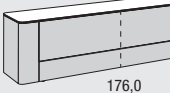
2 Raster lowboards with rounded end at one side					
		 <p>140,8</p> <p>158.4 cm wide</p>		 <p>176,0</p> <p>193.6 cm wide</p>	
	Flap hinge at bottom	1 drawer with split drawer frame	1 flap with 1 partition	1 drawer with split drawer frame	1 flap with 1 partition
		215111 215112	215181 215182	219111 219112	219181 219182
	Price gr.	-	-	-	-
		291L	292R	291L	292R
		-	-	-	-
		281L	282R	281L	282R
		-	-	-	-
		2145		2175	
		-		-	
					
		Functional frame for floor units	Functional frame for wall assembly	Functional frame for floor units	Functional frame for wall assembly
		2142	2143	2172	2173
		-	-	-	-
		14.5 W	24.0 W	16.0 W	27.0 W
					
		2144		2174	
		-		-	
					
		2141		2171	
		-		-	

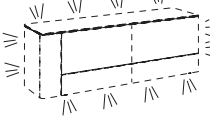
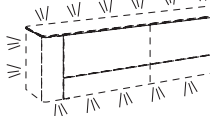
### 3 Raster lowboards with rounded end at one side

3 Raster lowboards with rounded end at one side 53.8 cm high (55.6 cm high incl. 1.8 cm high plinth adjusters), 45.0 cm deep  incl. cable aperture at centre of rear wall behind flap per compartment  <b>Wall units or wall assembly:</b> Please see here the information on page 4		3 Raster lowboards with rounded end at one side					
		70.4 cm wide		88.0 cm wide		123.2 cm wide	
		 52,8 70.4 cm wide		 70,4 88.0 cm wide		 105,6 123.2 cm wide	
Flap hinge at bottom		<b>Top:</b> 1 drawer <b>Bottom:</b> 1 drawer	<b>Top:</b> 1 drawer <b>Bottom:</b> 1 flap	<b>Top:</b> 1 drawer <b>Bottom:</b> 1 drawer	<b>Top:</b> 1 drawer <b>Bottom:</b> 1 flap	<b>Top:</b> 1 drawer <b>Bottom:</b> 1 drawer	<b>Top:</b> 1 drawer <b>Bottom:</b> 1 flap
as illustr. v. versa		<b>37111</b> <b>37112</b>	<b>37181</b> <b>37182</b>	<b>38111</b> <b>38112</b>	<b>38181</b> <b>38182</b>	<b>312111</b> <b>312112</b>	<b>312181</b> <b>312182</b>
Price gr. I II		- -	- -	- -	- -	- -	- -
		 52,8 70.4 cm wide		 70,4 88.0 cm wide		 105,6 123.2 cm wide	
Flap hinge at bottom		<b>Top:</b> 1 drawer <b>Bottom:</b> 1 drawer	<b>Top:</b> 1 flap <b>Bottom:</b> 1 drawer	<b>Top:</b> 1 drawer <b>Bottom:</b> 1 drawer	<b>Top:</b> 1 flap <b>Bottom:</b> 1 drawer	<b>Top:</b> 1 drawer <b>Bottom:</b> 1 drawer	<b>Top:</b> 1 flap <b>Bottom:</b> 1 drawer
as illustr. v. versa		<b>37211</b> <b>37212</b>	<b>37281</b> <b>37282</b>	<b>38211</b> <b>38212</b>	<b>38281</b> <b>38282</b>	<b>312211</b> <b>312212</b>	<b>312281</b> <b>312282</b>
Price gr. I II		- -	- -	- -	- -	- -	- -
<b>Drawer for end unit</b> left (L; as illustr.) or right (R; vice versa)		<b>391L</b>	<b>392R</b>	<b>391L</b>	<b>392R</b>	<b>391L</b>	<b>392R</b>
<b>Hinge-door for end unit</b> left (L; as illustr.) or right (R; vice versa)		<b>381L</b>	<b>382R</b>	<b>381L</b>	<b>382R</b>	<b>381L</b>	<b>382R</b>
<b>Wall bracket</b> If units are planned as wall units, a wall bracket must be ordered.  Max. load: 40 kg		<b>255</b>		<b>275</b>		<b>2105</b>	
<b>Functional frame for floor units</b> The units can be planned optionally with a functional frame for floor units.  <b>Functional frame for wall assembly</b> If you plan a functional frame for wall assembly, you require an extra wall bracket. In this case the plinth adjusters are omitted.  Max. load: 40 kg  Please note the further information on functional frames on page 7.							
		Functional frame for floor units	Functional frame for wall assembly	Functional frame for floor units	Functional frame for wall assembly	Functional frame for floor units	Functional frame for wall assembly
		<b>352</b>	<b>353</b>	<b>372</b>	<b>373</b>	<b>3102</b>	<b>3103</b>
		-	-	-	-	-	-
<b>Lamp for functional frame</b> The functional frame can be fitted with an optional LED lamp. LED lamp incl. footswitch. Lamp switch optionally with a remote control unit (against surcharge; see page 38). Later fitting not possible.  This luminaire contains built-in LED lamps of the energy classes A++ to A. The lamps cannot be changed in the luminaire. 12 V		11.0 W	15.5 W	12.5 W	18.0 W	15.0 W	23.5 W
							
		<b>354</b>		<b>374</b>		<b>3104</b>	
		-		-		-	
<b>Metal substructure</b> 19.4 cm high; High-gloss chrome  The units can be planned optionally on a metal substructure. In this case the plinth adjusters are omitted.							
		<b>251</b>		<b>271</b>		<b>2101</b>	
		-		-		-	

3 Raster lowboards with rounded end at one side					
		 <p>140,8 158.4 cm wide</p>		 <p>176,0 193.6 cm wide</p>	
Flap hinge at bottom	<p><b>Top:</b> 1 drawer with split drawer frame <b>Bottom:</b> 1 drawer with split drawer frame</p>	<p><b>Top:</b> 1 drawer with split drawer frame <b>Bottom:</b> 1 flap with 1 partition</p>	<p><b>Top:</b> 1 drawer with split drawer frame <b>Bottom:</b> 1 drawer with split drawer frame</p>	<p><b>Top:</b> 1 drawer with split drawer frame <b>Bottom:</b> 1 flap with 1 partition</p>	
Price gr.	<p><b>315111</b> <b>315112</b></p> <p>- -</p>	<p><b>315181</b> <b>315182</b></p> <p>- -</p>	<p><b>319111</b> <b>319112</b></p> <p>- -</p>	<p><b>319181</b> <b>319182</b></p> <p>- -</p>	
		 <p>140,8 158.4 cm wide</p>		 <p>176,0 193.6 cm wide</p>	
Flap hinge at bottom	<p><b>Top:</b> 1 drawer with split drawer frame <b>Bottom:</b> 1 drawer with split drawer frame</p>	<p><b>Top:</b> 1 flap with 1 partition <b>Bottom:</b> 1 drawer with split drawer frame</p>	<p><b>Top:</b> 1 drawer with split drawer frame <b>Bottom:</b> 1 drawer with split drawer frame</p>	<p><b>Top:</b> 1 flap with 1 partition <b>Bottom:</b> 1 drawer with split drawer frame</p>	
Price gr.	<p><b>315211</b> <b>315212</b></p> <p>- -</p>	<p><b>315281</b> <b>315282</b></p> <p>- -</p>	<p><b>319211</b> <b>319212</b></p> <p>- -</p>	<p><b>319281</b> <b>319282</b></p> <p>- -</p>	
		<p><b>391L</b></p> <p>-</p>	<p><b>392R</b></p> <p>-</p>	<p><b>391L</b></p> <p>-</p>	<p><b>392R</b></p> <p>-</p>
		<p><b>381L</b></p> <p>-</p>	<p><b>382R</b></p> <p>-</p>	<p><b>381L</b></p> <p>-</p>	<p><b>382R</b></p> <p>-</p>
		<p><b>2145</b></p> <p>-</p>		<p><b>2175</b></p> <p>-</p>	
					
		<p>Functional frame for floor units</p>	<p>Functional frame for wall assembly</p>	<p>Functional frame for floor units</p>	<p>Functional frame for wall assembly</p>
		<p><b>3142</b></p> <p>-</p>	<p><b>3143</b></p> <p>-</p>	<p><b>3172</b></p> <p>-</p>	<p><b>3173</b></p> <p>-</p>
		<p>16.0 W</p>	<p>26.5 W</p>	<p>18.5 W</p>	<p>30.0 W</p>
					
		<p><b>3144</b></p> <p>-</p>		<p><b>3174</b></p> <p>-</p>	
					
		<p><b>2141</b></p> <p>-</p>		<p><b>2171</b></p> <p>-</p>	

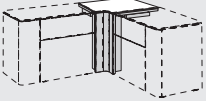
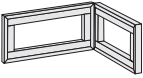
## 2 and 3 Raster corner units

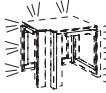





<p><b>2 and 3 Raster corner units</b> 36.2 or 53.8 cm high (38.0 or 55.6 cm high incl. 1.8 cm high plinth adjusters), 45.0 cm deep</p> <p><b>Wall units or wall assembly:</b> Please see here the information on page 4</p> <p><b>Corner shelf incl. vertical cover panel</b> If 2 and 3 Raster GENTIS units are fitted round a corner, it is possible to fit corner shelves incl. vertical panels (non-accessible corner). Only units of the same height can be fitted round the corner.</p>		2 Raster corner units	3 Raster corner units
		<div style="display: flex; justify-content: space-around; align-items: center;">   </div> <div style="display: flex; justify-content: space-around; align-items: center;"> <p>56.2 x 56.2 cm wide</p> <p>56.2 x 56.2 cm wide</p> </div> <div style="display: flex; justify-content: space-around; align-items: center;"> <p>Corner shelf incl. vertical cover panel</p> <p>Corner shelf incl. vertical cover panel</p> </div>	<p style="text-align: center;"><b>266</b></p> <p style="text-align: center;">-</p> <p style="text-align: center;">-</p>
<p><b>Functional frame for corners</b> The units can be planned optionally with a functional frame for floor units.</p> <p><b>Functional frame for wall assembly</b> If you plan a functional frame for wall assembly for the 2 and 3 Raster corner units, you <b>do not</b> require an extra wall bracket.</p> <p>Max. load: 40 kg</p> <p>Please note the further information on functional frames on page 7.</p>		<div style="text-align: center;">  <p>Functional frame for floor units and wall assembly</p> <p><b>262</b></p> <p style="text-align: center;">-</p> <p>26.0 W</p>  <p><b>264</b></p> <p style="text-align: center;">-</p> </div>	<div style="text-align: center;">  <p>Functional frame for floor units and wall assembly</p> <p><b>362</b></p> <p style="text-align: center;">-</p> <p>30.0 W</p>  <p><b>364</b></p> <p style="text-align: center;">-</p> </div>
<p><b>Lamp for functional frame</b> The functional frame can be fitted with an optional LED lamp. LED lamp incl. footswitch. Lamp switch optionally with a remote control unit (against surcharge; see page 38). Later fitting not possible.</p> <p>This luminaire contains built-in LED lamps of the energy classes A++ to A. The lamps cannot be changed in the luminaire. 12 V</p>			

## 2 Raster lowboards with rounded end at both sides

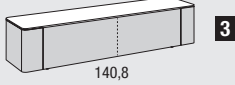
Assembly notes for wall units:  
Please be sure to note here the information  
and notes in the "Wall composition" chapter!

3  
4

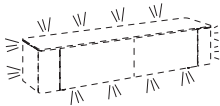
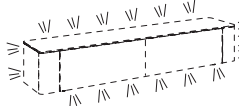
GENTIS

2 Raster lowboards with rounded end at both sides 36.2 cm high (38.0 cm high incl. 1.8 cm high plinth adjusters), 45.0 cm deep  incl. cable aperture at centre of rear wall behind flap per compartment  <b>Wall units or wall assembly:</b> Please see here the information on page 4		2 Raster lowboards with rounded end at both sides			
		176.0 cm wide		211.2 cm wide	
					
Flap hinge at bottom	1 drawer with split drawer frame	1 flap with 1 partition	1 drawer with split drawer frame	1 flap with 1 partition	
	<b>21721</b>	<b>21728</b>	<b>22121</b>	<b>22128</b>	
Price gr.	-	-	-	-	
	-	-	-	-	
<b>NEW</b> Drawer for end unit optionally left (L) and/or right (R)	<b>291L</b>	<b>292R</b>	<b>291L</b>	<b>292R</b>	
	-	-	-	-	
<b>NEW</b> Hinge-door for end unit optionally left (L) and/or right (R)	<b>281L</b>	<b>282R</b>	<b>281L</b>	<b>282R</b>	
	-	-	-	-	
<b>Wall bracket</b> If units are planned as wall units, a wall bracket must be ordered.  Max. load: 40 kg	<b>2145</b>		<b>2175</b>		
	-		-		
<b>Functional frame for floor units</b> The units can be planned optionally with a functional frame for floor units.  <b>Functional frame for wall assembly</b> If you plan a functional frame for wall assembly, you require an extra wall bracket. In this case the plinth adjusters are omitted.  Max. load: 40 kg  Please note the further information on functional frames on page 7.					
	Functional frame for floor units	Functional frame for wall assembly	Functional frame for floor units	Functional frame for wall assembly	
	<b>2142</b>	<b>2143</b>	<b>2172</b>	<b>2173</b>	
	-	-	-	-	
<b>Lamp for functional frame</b> The functional frame can be fitted with an optional LED lamp. LED lamp incl. footswitch. Lamp switch optionally with a remote control unit (against surcharge; see page 38). Later fitting not possible.  This luminaire contains built-in LED lamps of the energy classes A+++ to A. The lamps cannot be changed in the luminaire. 12 V	14.5 W	24.0 W	16.0 W	27.0 W	
					
	<b>2144</b>		<b>2174</b>		
	-		-		
<b>Metal substructure</b> 19.4 cm high; High-gloss chrome  The units can be planned optionally on a metal substructure. In this case the plinth adjusters are omitted.					
	<b>2141</b>		<b>2171</b>		
	-		-		



### 3 Raster lowboards with rounded end at both sides

**3 Raster lowboards with rounded end at both sides**  
 53.8 cm high  
 (55.6 cm high incl. 1.8 cm high plinth adjusters),  
 45.0 cm deep

incl. cable aperture at centre of rear wall behind flap per compartment

**Wall units or wall assembly:**  
 Please see here the information on page 4

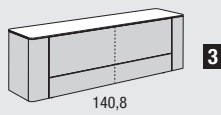
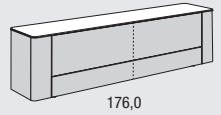
3 Raster lowboards with rounded end at both sides				
	 <p>140,8</p> <p>176.0 cm wide</p>		 <p>176,0</p> <p>211.2 cm wide</p>	
Flap hinge at bottom	2 drawers with split drawer frames	<b>Top:</b> 1 flap with 1 partition <b>Bottom:</b> 1 drawer with split drawer frame	2 drawers with split drawer frames	<b>Top:</b> 1 flap with 1 partition <b>Bottom:</b> 1 drawer with split drawer frame
	<b>31711</b>	<b>31718</b>	<b>32111</b>	<b>32118</b>
Price gr.	-	-	-	-
	-	-	-	-

**NEW**

**NEW**

**Drawer for end unit**  
 optionally left (L) and/or right (R)

	<b>391L</b>	<b>392R</b>	<b>391L</b>	<b>392R</b>
	-	-	-	-

**Hinge-door for end unit**  
 optionally left (L) and/or right (R)

	<b>381L</b>	<b>382R</b>	<b>381L</b>	<b>382R</b>
	-	-	-	-



**Wall bracket**  
 If units are planned as wall units, a wall bracket must be ordered.  
 Max. load: 40 kg

	<b>2145</b>	<b>2175</b>
	-	-

**Functional frame for floor units**  
 The units can be planned optionally with a functional frame for floor units.

**Functional frame for wall assembly**  
 If you plan a functional frame for wall assembly, you require an extra wall bracket. In this case the plinth adjusters are omitted.  
 Max. load: 40 kg

Please note the further information on functional frames on page 7.

				
	Functional frame for floor units	Functional frame for wall assembly	Functional frame for floor units	Functional frame for wall assembly
	<b>3142</b>	<b>3143</b>	<b>3172</b>	<b>3173</b>
	-	-	-	-

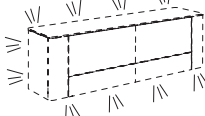
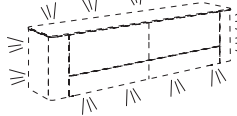

**Lamp for functional frame**  
 The functional frame can be fitted with an optional LED lamp. LED lamp incl. footswitch. Lamp switch optionally with a remote control unit (against surcharge; see page 38). Later fitting not possible.

This luminaire contains built-in LED lamps of the energy classes A+++ to A. The lamps cannot be changed in the luminaire. 12 V

	16.0 W	26.5 W	18.5 W	30.0 W
				
	<b>3144</b>	<b>3174</b>		
	-	-		







**Metal substructure**  
 19.4 cm high;  
 High-gloss chrome

The units can be planned optionally on a metal substructure. In this case the plinth adjusters are omitted.

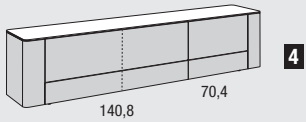
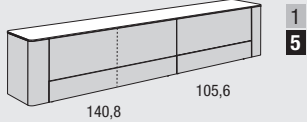
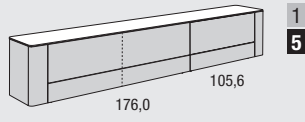
				
	<b>2141</b>	<b>2171</b>		
	-	-		

**Notes on delivery:**  
Please see here the information on range introduction pages.

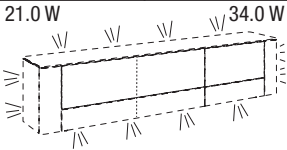
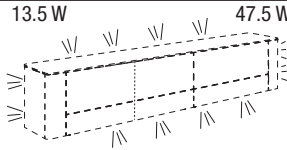
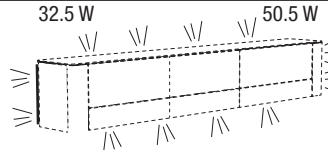
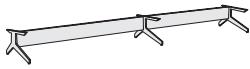
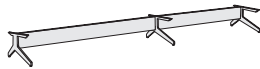
**Assembly notes for wall units:**  
Please be sure to note here the information and notes in the "Wall composition" chapter!

3 Raster lowboards with rounded end at both sides										
										
		246.4 cm wide			281.6 cm wide			316.8 cm wide		
Flap hinge at bottom	4 drawers (wide drawers with split drawer frames)	<b>Top:</b> 2 flaps (wide flap with 1 partition) <b>Bottom:</b> 2 drawers (wide drawer with split drawer frame)	<b>Top:</b> 1 flap with 1 partition, 1 drawer <b>Bottom:</b> 2 drawers (wide drawer with split drawer frame)	4 drawers (wide drawers with split drawer frames)	<b>Top:</b> 2 flaps (wide flap with 1 partition) <b>Bottom:</b> 2 drawers (wide drawer with split drawer frame)	<b>Top:</b> 1 flap with 1 partition, 1 drawer <b>Bottom:</b> 2 drawers (wide drawer with split drawer frame)	4 drawers (wide drawers with split drawer frames)	<b>Top:</b> 2 flaps (wide flap with 1 partition) <b>Bottom:</b> 2 drawers (wide drawer with split drawer frame)	<b>Top:</b> 1 flap with 1 partition, 1 drawer <b>Bottom:</b> 2 drawers (wide drawer with split drawer frame)	
as illustr. v. versa	324111 324112	324181 324182	324171 324172	328111 328112	328181 328182	328171 328172	331111 331112	331181 331182	331171 331172	
Price gr.	-	-	-	-	-	-	-	-	-	
	391L		392R	391L		392R	391L		392R	
	-		-	-		-	-		-	
	381L		382R	381L		382R	381L		382R	
	-		-	-		-	-		-	
	2215			2245			2285			
	-			-			-			
										
	Functional frame for floor units		Functional frame for wall assembly	Functional frame for floor units		Functional frame for wall assembly	Functional frame for floor units		Functional frame for wall assembly	
	3212		3213	3242		3243	3282		3283	
	-		-	-		-	-		-	
	21.0 W		34.0 W	13.5 W		47.5 W	32.5 W		50.5 W	
										
	3214			3244			3284			
	-			-			-			
										
	2211			2241			2281			
	-			-			-			

# Media accessories for lowboards

## Multiple socket

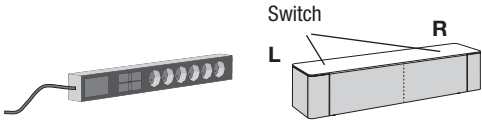
<p><b>Multiple socket</b> Fitting of multiple socket in lowboards in front of rear wall optionally left (L) or right (R) in the compartment behind flap, fitting of switch in wooden cover shelf, optionally left or right (see sketch). Please state the required position clearly in the order! 7.4 cm high, 44.6 cm long, 5.7 cm deep</p>		<p><b>Multiple socket with on/off function</b> all 6 sockets permanent current</p>
		<p>291 L 292 R -</p>

## IR repeater set

<p><b>IR repeater set</b> Infrared signal transmission set for operating media units behind wooden/lacquered fronts. You can operate all the units in one compartment with one set. The following applies:</p> <ul style="list-style-type: none"> <li>• One set must be used in each compartment. 2 transmitters can also be installed in large compartments in order to increase performance. In this case only one additional transmitter needs to be ordered.</li> <li>• The transmitter must be placed in the direct vicinity of the receiver eye.</li> <li>• Transmittable IR frequency band 20 – 60 kHz</li> <li>• Up to 3 transmitters can be combined with one receiver.</li> </ul> <p>It is possible to use 3 transmitters via 1 receiver including Master box. This enables simultaneous operation of 3 different furniture compartments or in critical situations it allows fitting out one furniture compartment with several transmitters in order to increase the performance in this compartment or to operate 2 end units placed next to one another.</p> <p>The IR repeater set consists of:</p> <ul style="list-style-type: none"> <li>• 1 receiver eye (Ø 3.0 cm) incl. standing bracket</li> <li>• 1 electrical transmitter</li> <li>• 1 plug EVG 12 V</li> <li>• Cable clips</li> </ul> <p>Please note the details stated in the operating instructions!</p>	<p><b>IR repeater set</b> 1 receiver eye and 1 transmitter incl. standing bracket</p>
	<p>2001 -</p>
	<p><b>Extra transmitter</b></p>
	<p>2003 -</p>



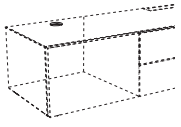
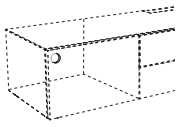
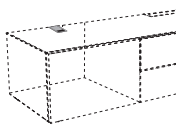
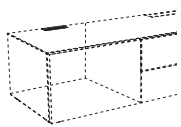
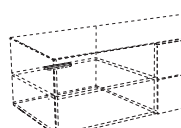
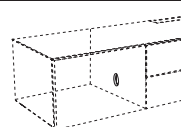
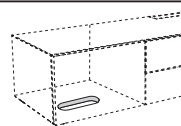



## Cable apertures / subwoofer base cut-out section

	<p><b>Cable aperture K1</b> silver-coloured; Ø 8.0 cm It is possible to fit a cable aperture in the top shelf of the lowboard. The cable aperture can be made at the rear of the top shelf. The position is in the centre of the compartment, distance from centre of aperture to rear edge of unit: 10.0 cm.</p>	<p>K1 -</p>
	<p><b>Cable aperture K2</b> silver-coloured; Ø 8.0 cm It is possible to fit a cable aperture in the rear wall of the lowboard. Positioned at centre of compartment.</p>	<p>K2 -</p>
	<p><b>Cable aperture K7</b> silver-coloured; 7.0 x 12.0 cm It is possible to fit a cable aperture in the top shelf of the lowboard. The position is in the centre of the compartment, flush with the rear edge of the unit.</p>	<p>K7 -</p>
	<p><b>Cable aperture K8</b> silver-coloured; 12.8 x 3.2 cm It is possible to fit a cable aperture in the top shelf of the lowboard. The cable aperture can be made at the rear rim of the top shelf. Positioned in centre of compartment.</p>	<p>K8 -</p>
	<p><b>Cable aperture K9</b> 13.0 x 1.6 cm It is possible to fit a cable aperture in a fitted shelf. The cable aperture can be made at the rear rim of the fitted shelf. Positioned in centre of compartment.</p>	<p>K9 -</p>
	<p><b>Cable aperture K20</b> silver-coloured; Ø 8.0 cm It is possible to fit a cable aperture in the partitions of the lowboard.</p>	<p>K20 -</p>
	<p><b>Subwoofer base cut-out section</b> Base cut-out section 12 x 23.2 cm The sounds from the subwoofer pass out through the base cut-out section in the lowboard without hindrance. The exact position in the carcass is predetermined ex-works and cannot be altered.</p>	<p>14 -</p>

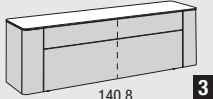
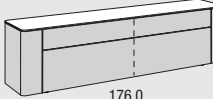
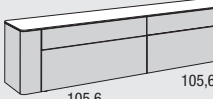
# 3 Raster sideboards with rounded end at both sides

Assembly notes for wall units:  
Please be sure to note here the information  
and notes in the "Wall composition" chapter!

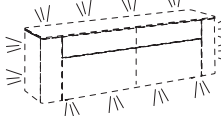
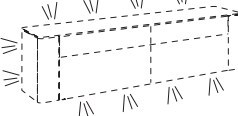
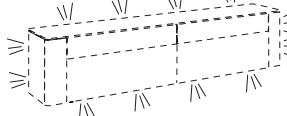
GENTIS

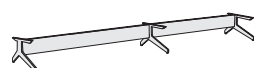
3 Raster sideboards with rounded end at both sides 53.8 cm high (55.6 cm high incl. 1.8 cm high plinth adjusters), 45.0 cm deep		3 Raster sideboards with rounded end at both sides						
		176.0 cm wide		211.2 cm wide		246.4 cm wide		
<b>Wall units or wall assembly:</b> Please see here the information on page 4		 140,8 <b>3</b>		 176,0 <b>3</b>		 105,6 105,6 <b>3</b>		
Flap hinge at bottom		2 drawers with split drawer frames	<b>Top:</b> 1 drawer with split drawer frame <b>Bottom:</b> 1 flap with 1 partition	2 drawers with split drawer frames	<b>Top:</b> 1 drawer with split drawer frame <b>Bottom:</b> 1 flap with 1 partition	4 drawers	<b>Top:</b> 2 drawers <b>Bottom:</b> 2 flaps	<b>Top:</b> 2 drawers <b>Bottom:</b> 1 drawer, 1 flap
as illustr. v. versa		<b>31731</b>	<b>31738</b>	<b>32131</b>	<b>32138</b>	<b>32431</b>	<b>32438</b>	<b>324371</b> <b>324372</b>
Price gr.		-	-	-	-	-	-	-
I		-	-	-	-	-	-	-
II		-	-	-	-	-	-	-
<b>NEW</b>	<b>Drawer for end unit</b> optionally left (L) and/or right (R)	<b>391L</b>	<b>392R</b>	<b>391L</b>	<b>392R</b>	<b>391L</b>	<b>392R</b>	
		-	-	-	-	-	-	
<b>NEW</b>	<b>Hinge-door for end unit</b> optionally left (L) and/or right (R)	<b>381L</b>	<b>382R</b>	<b>381L</b>	<b>382R</b>	<b>381L</b>	<b>382R</b>	
		-	-	-	-	-	-	
<b>Wall bracket</b> If units are planned as wall units, a wall bracket must be ordered.  Max. load: 40 kg		<b>2145</b>		<b>2175</b>		<b>2215</b>		
		-		-		-		
<b>Functional frame for floor units</b> The units can be planned optionally with a functional frame for floor units.  <b>Functional frame for wall assembly</b> If you plan a functional frame for wall assembly, you require an extra wall bracket. In this case the plinth adjusters are omitted.  Max. load: 40 kg  Please note the further information on functional frames on page 7.								
		Functional frame for floor units	Functional frame for wall assembly	Functional frame for floor units	Functional frame for wall assembly	Functional frame for floor units	Functional frame for wall assembly	
		<b>3142</b>	<b>3143</b>	<b>3172</b>	<b>3173</b>	<b>3212</b>	<b>3213</b>	
		-	-	-	-	-	-	
<b>Lamp for functional frame</b> The functional frame can be fitted with an optional LED lamp. LED lamp incl. footswitch. Lamp switch optionally with a remote control unit (against surcharge; see page 38). Later fitting not possible.  This luminaire contains built-in LED lamps of the energy classes A+++ to A. The lamps cannot be changed in the luminaire. 12 V		16.0 W	26.5 W	19.0 W	30.0 W	28.5 W	42.5 W	
								
		<b>3144</b>		<b>3174</b>		<b>3214</b>		
		-		-		-		
<b>Metal substructure</b> 19.4 cm high; High-gloss chrome  The units can be planned optionally on a metal substructure. In this case the plinth adjusters are omitted.								
		<b>2141</b>		<b>2171</b>		<b>2211</b>		
		-		-		-		

# 4 Raster sideboards with rounded end at both sides

**4 Raster sideboards with rounded end at both sides**  
71.4 cm high  
(73.2 cm high incl. 1.8 cm high plinth adjusters),  
45.0 cm deep

**Wall units or wall assembly, standard interior fittings:**  
Please see here the information on page 4

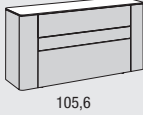
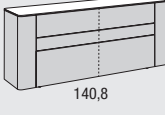
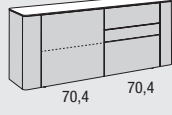
4 Raster sideboards with rounded end at both sides						
	 105,6 140.8 cm wide	 140,8 176.0 cm wide	 70,4 70,4 176.0 cm wide			
Flap hinge at bottom	3 drawers <b>Top/Centre:</b> 2 drawers <b>Bottom:</b> 1 flap	3 drawers with split drawer frames <b>Top/Centre:</b> 2 drawers with split drawer frames <b>Bottom:</b> 1 flap with 1 partition	Left: 1 door Right: 3 drawers	Left: 1 door Top right/Centre: 2 drawers Bottom right: 1 flap		
as illustr. v. versa	<b>41431</b>	<b>41438</b>	<b>41731</b>	<b>41738</b>	<b>417511</b> <b>417512</b>	<b>417581</b> <b>417582</b>
Price gr. I II	- -	- -	- -	- -	- -	- -

**NEW**  
**NEW**

**Drawer for end unit**  
optionally left (L) and/or right (R)

	<b>491L</b>	<b>492R</b>	<b>491L</b>	<b>492R</b>	<b>491L</b>	<b>492R</b>
	-	-	-	-	-	-

**Hinge-door for end unit**  
optionally left (L) and/or right (R)

	<b>481L</b>	<b>482R</b>	<b>481L</b>	<b>482R</b>	<b>481L</b>	<b>482R</b>
	-	-	-	-	-	-



**Wall bracket**  
If units are planned as wall units, a wall bracket must be ordered.  
Max. load: 40 kg

	<b>2105</b>	<b>2145</b>	<b>2145</b>
	-	-	-

**Functional frame for floor units**  
The units can be planned optionally with a functional frame for floor units.

**Functional frame for wall assembly**  
If you plan a functional frame for wall assembly, you require an extra wall bracket. In this case the plinth adjusters are omitted.  
Max. load: 40 kg

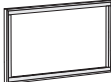

Please note the further information on functional frames on page 7.

					
Functional frame for floor units	Functional frame for wall assembly	Functional frame for floor units	Functional frame for wall assembly	Functional frame for floor units	Functional frame for wall assembly
<b>4102</b>	<b>4103</b>	<b>4142</b>	<b>4143</b>	<b>4142</b>	<b>4143</b>
-	-	-	-	-	-

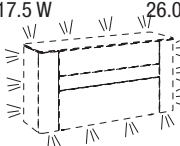
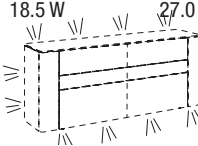
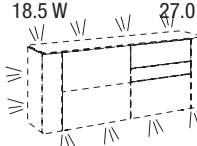
**Lamp for functional frame**  
The functional frame can be fitted with an optional LED lamp. LED lamp incl. footswitch. Lamp switch optionally with a remote control unit (against surcharge; see page 38). Later fitting not possible.  
This luminaire contains built-in LED lamps of the energy classes A+++ to A. The lamps cannot be changed in the luminaire. 12 V







		
<b>4104</b>	<b>4144</b>	<b>4144</b>
-	-	-

**Metal substructure**  
19.4 cm high;  
High-gloss chrome  
The units can be planned optionally on a metal substructure. In this case the plinth adjusters are omitted.

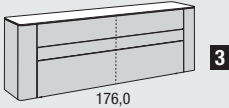
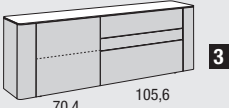
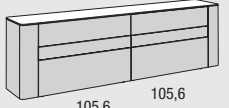
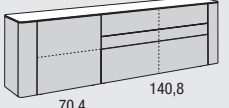
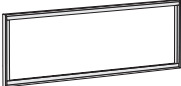
		
<b>2101</b>	<b>2141</b>	<b>2141</b>
-	-	-

**Notes on delivery:**  
Please see here the information on range introduction pages.

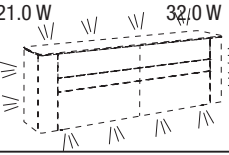
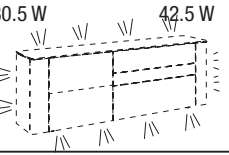
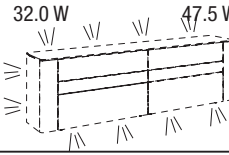
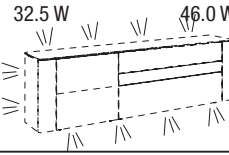
**Assembly notes for wall units:**  
Please be sure to note here the information and notes in the "Wall composition" chapter!

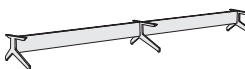
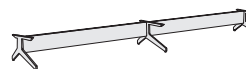

4 Raster sideboards with rounded end at both sides											
											
		211.2 cm wide		211.2 cm wide		246.4 cm wide		246.4 cm wide			
	Flap hinge at bottom	3 drawers with split drawer frames		Left: 1 door Right: 3 drawers		Left: 1 door Top right/Centre: 2 drawers Bottom right: 1 flap		6 drawers		Top/Centre: 4 drawers Bottom: 2 flaps	
		Top/Centre: 2 drawers with split drawer frames Bottom: 1 flap with 1 partition						Top/Centre: 4 drawers Bottom left: 1 drawer Bottom right: 1 flap		Left: 1 door Right: 3 drawers with split drawer frames	
										Left: 1 door Top right/Centre: 2 drawers with split drawer frames Bottom right: 1 flap with 1 partition	
	as illustr. v. versa	42131	42138	421511 421512	421581 421582	42431	42438	424371 424372	424511 424512	424581 424582	
	Price gr.	-	-	-	-	-	-	-	-	-	
		491L	492R	491L	492R	491L	492R	491L	492R	491L	492R
		-	-	-	-	-	-	-	-	-	-
		481L	482R	481L	482R	481L	482R	481L	482R	481L	482R
		-	-	-	-	-	-	-	-	-	-
		2175		2175		2215		2215			
											
		Functional frame for floor units	Functional frame for wall assembly	Functional frame for floor units	Functional frame for wall assembly	Functional frame for floor units	Functional frame for wall assembly	Functional frame for floor units	Functional frame for wall assembly		
		4172	4173	4172	4173	4212	4213	4212	4213		
		-	-	-	-	-	-	-	-		
		21.0 W	32.0 W	30.5 W	42.5 W	32.0 W	47.5 W	32.5 W	46.0 W		
											
		4174		4174		4214		4214			
		-		-		-		-			
											
		2171		2171		2211		2211			
		-		-		-		-			

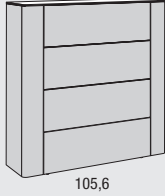
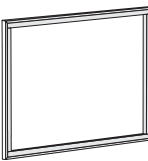
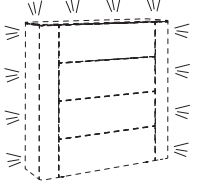

# 8 Raster highboard with rounded end at both sides

<b>8 Raster highboard with rounded end at both sides</b> 141.8 cm high (143.6 cm high incl. 1.8 cm high plinth adjusters), 45.0 cm deep  Cannot be fitted as a wall unit!	<b>8 Raster highboard with rounded end at both sides</b>				
	 105,6 140.8 cm wide				
	Flap hinge at bottom	4 drawers	<b>Top:</b> 1 flap <b>Bottom:</b> 3 drawers	<b>Top:</b> 2 flaps <b>Bottom:</b> 2 drawers	<b>Top:</b> 3 flaps <b>Bottom:</b> 1 drawer
	Price gr.	<b>81411</b>	<b>81418</b>	<b>81417</b>	<b>81416</b>
	-	-	-	-	
<b>NEW</b> <b>Drawer for end unit</b> optionally left (L) and/or right (R)		<b>891L</b>		<b>892R</b>	
		-		-	
<b>NEW</b> <b>Hinge-door for end unit</b> optionally left (L) and/or right (R)		<b>881L</b>		<b>882R</b>	
		-		-	
<b>Functional frame for floor units</b> The units can be planned optionally with a functional frame for floor units.  Please note the further information on functional frames on page 7.					
	Functional frame for floor units				
	<b>8102</b>				
<b>Lamp for functional frame</b> The functional frame can be fitted with an optional LED lamp. LED lamp incl. footswitch. Lamp switch optionally with a remote control unit (against surcharge; see page 38). Later fitting not possible.  This luminaire contains built-in LED lamps of the energy classes A++ to A. The lamps cannot be changed in the luminaire. 12 V	26.0 W 				
	<b>8104</b>				
	-				

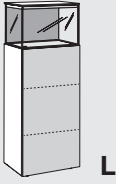
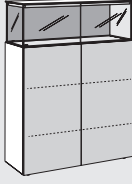
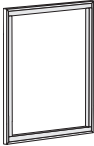
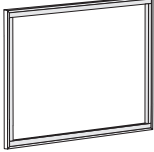
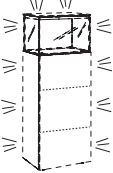
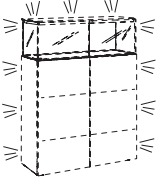
# 8 Raster cabinets

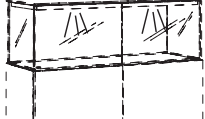

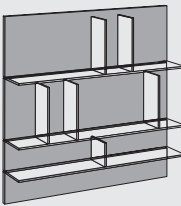
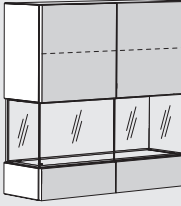
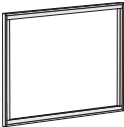
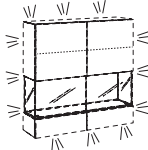
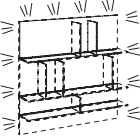
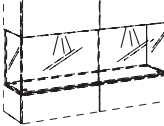

<p><b>8 Raster cabinets</b> 141.8 cm high (143.6 cm high incl. 1.8 cm high plinth adjusters), 45.0 cm deep</p> <p><b>Standard interior fittings and notes on cabinets:</b> Please see here the information on page 4</p> <p>Cannot be fitted as a wall unit!</p>	<b>8 Raster cabinets</b>	
	 <p>52.8 cm wide</p> <p>1 door with glass panel</p>	 <p>105.6 cm wide</p> <p>2 doors with glass panel</p>
	<p><b>85141 L</b> <b>85142 R</b></p> <p>Price gr. I - II -</p>	<p><b>81014</b></p> <p>-</p>
<p><b>Functional frame for floor units</b> The units can be planned optionally with a functional frame for floor units.</p> <p>Please note the further information on functional frames on page 7.</p>	 <p>Functional frame for floor units</p>	 <p>Functional frame for floor units</p>
	<p><b>852</b></p> <p>-</p>	<p><b>8102</b></p> <p>-</p>
	<p>21.5 W</p> 	<p>25.5 W</p> 
<p><b>Lamp for functional frame</b> The functional frame can be fitted with an optional LED lamp. LED lamp incl. footswitch. Lamp switch optionally with a remote control unit (against surcharge; see page 38). Later fitting not possible.</p> <p>This luminaire contains built-in LED lamps of the energy classes A++ to A. The lamps cannot be changed in the luminaire. 12 V</p>	<p><b>854</b></p> <p>-</p>	<p><b>8104</b></p> <p>-</p>
	<p>2.9 W</p> 	<p>2x 2.9 W</p> 
	<p><b>7941</b></p> <p>-</p>	<p>For type <b>81014</b> 2 integrated LED spotlamps must be ordered!</p> <p>2x <b>7941</b> 2x -</p>

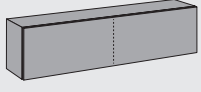
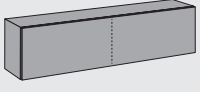
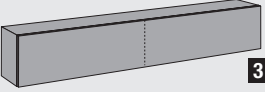

## 6 Raster wall units

<p><b>6 Raster wall shelf</b> 105.6 cm high <b>26.2 cm deep</b></p> <p><b>6 Raster wall cabinet</b> 105.6 cm high <b>33.0 cm deep</b></p> <p><b>Notes on wall shelf and wall cabinet:</b> Please see here the information on page 6</p> <p>Max. load wall shelf and wall cabinet: 20 kg</p>	<p><b>6 Raster wall shelf</b></p>  <p>105.6 cm wide</p> <p>3 glass shelves, 6 glass partitions</p> <p><b>61019</b></p> <p>Price gr. I - II - III -</p>	<p><b>6 Raster wall cabinet</b></p>  <p>105.6 cm wide</p> <p>2 doors with glass panel</p> <p><b>61014</b></p> <p>Price gr. I - II -</p>
<p><b>Functional frame for wall assembly</b> If you plan a functional frame for wall assembly for the 6 Raster wall cabinet, you <b>do not</b> require an extra wall bracket.</p> <p>Max. load: 20 kg</p> <p>Please note the further information on functional frames on page 7.</p>		 <p>Functional frame for wall assembly</p> <p><b>6106</b></p> <p>-</p>
<p><b>Lamp for functional frame</b> The functional frame can be fitted with an optional LED lamp. LED lamp incl. footswitch. Lamp switch optionally with a remote control unit (against surcharge; see page 38). Later fitting not possible.</p> <p>This luminaire contains built-in LED lamps of the energy classes A++ to A. The lamps cannot be changed in the luminaire. 12 V</p>		<p>27.5 W</p>  <p><b>6104</b></p> <p>-</p>
<p><b>Lamp for wall shelf</b> The wall shelf can be fitted with an optional LED lamp. LED lamp incl. footswitch. Lamp switch optionally with a remote control unit (against surcharge; see page 38).</p> <p>This luminaire contains built-in LED lamps of the energy classes A++ to A. The lamps cannot be changed in the luminaire. 12 V</p>	<p>30.0 W</p>  <p><b>6114</b></p> <p>-</p>	
<p><b>Integrated LED spotlamps for wall cabinet</b> Ø 7.1 cm The cabinet can be fitted with optional integrated LED spotlamps. Integrated LED spotlamps incl. footswitch. Lamp switch optionally with a remote control unit (against surcharge; see page 38).</p> <p>This luminaire contains built-in LED lamps of the energy classes A++ to A. The lamps cannot be changed in the luminaire. 12 V</p> <p><b>Note:</b> For type <b>61014</b> 2 integrated LED spotlamps must be ordered!</p>		<p>2x 2.9 W</p>  <p>2x <b>7941</b> 2x -</p>

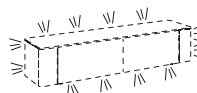
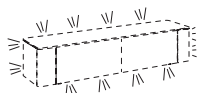
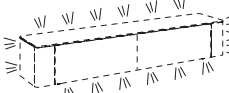

# Accent units

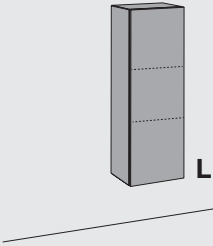
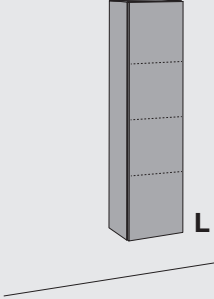
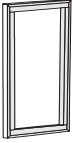
<p><b>2 Raster wall accent units</b> 35.2 cm high (in leather version: 36.8 cm); 33.0 cm deep</p> <p><b>6 Raster wall accent unit</b> 105.6 cm high (in leather version: 107.2 cm); 33.0 cm deep</p> <p><b>8 Raster wall accent unit</b> 140.8 cm high (in leather version: 142.4 cm); 33.0 cm deep</p> <p><b>Notes on accent units:</b> Carcase and front also in the versions knotted oak, knotted oak anthracite, knotted core walnut, Nappa leather and Nubuk-Touch leather possible. The inside carcass of accent units in leather version is in matt grey lacquer. If accent units are required in a leather version, the unit width increases by 1.6 cm.</p> <p><b>Wall units or wall assembly:</b> Please see here the information on page 4</p>	<b>2 Raster wall accent units</b>						
	 <p style="text-align: center;">105.6 cm wide (in leather version: 107.2 cm)</p>		 <p style="text-align: center;">140.8 cm wide (in leather version: 142.4 cm)</p>		 <p style="text-align: center;">176.0 cm wide (in leather version: 177.6 cm)</p>		
	1 flap with 1 partition (flap hinge at bottom)	1 flap with 1 partition (flap hinge at top)	1 flap with 1 partition (flap hinge at bottom)	1 flap with 1 partition (flap hinge at top)	1 flap with 1 partition (flap hinge at bottom)	1 flap with 1 partition (flap hinge at top)	
	<b>2108</b>	<b>2109</b>	<b>2148</b>	<b>2149</b>	<b>2178</b>	<b>2179</b>	
Price gr.	-	-	-	-	-		
I	-	-	-	-	-		
II	-	-	-	-	-		
III	-	-	-	-	-		
IV	-	-	-	-	-		
<p><b>Functional frame for wall assembly</b> If you plan a functional frame for wall assembly for the wall accent units, you <b>do not</b> require an extra wall bracket.</p> <p>Max. load: 20 kg</p> <p>Please note the further information on functional frames on page 7.</p>							
	Functional frame for wall assembly		Functional frame for wall assembly		Functional frame for wall assembly		
	<b>2106</b>	<b>2146</b>	<b>2176</b>				
<p><b>Lamp for functional frame</b> The functional frame can be fitted with an optional LED lamp. LED lamp incl. footswitch. Lamp switch optionally with a remote control unit (against surcharge; see page 38). Later fitting not possible.</p> <p>This luminaire contains built-in LED lamps of the energy classes A++ to A. The lamps cannot be changed in the luminaire. 12 V</p>	19.5 W		22.5 W		27.5 W		
							
	<b>2104</b>	<b>2144</b>	<b>2174</b>				

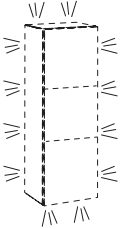
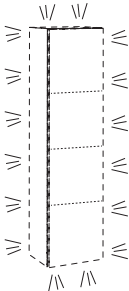
		6 Raster wall accent unit	8 Raster wall accent unit	
		 <p>35.2 cm wide (in leather version: 36.8 cm)</p>	 <p>35.2 cm wide (in leather version: 36.8 cm)</p>	
		1 door; 2 fitted shelves	1 door; 3 fitted shelves	
Price gr.		<b>632311 L</b> <b>632312 R</b> - - - -	<b>832311 L</b> <b>832312 R</b> - - - -	
I				
II				
III				
IV				
				
		Functional frame for wall assembly	Functional frame for wall assembly	
		<b>636</b> - 19.5 W	<b>836</b> - 22.5 W	
				
		<b>634</b> -	<b>834</b> -	



## Accessories for units

### Fitted shelves

 <b>Fitted shelf</b> 1.9 cm thick			in 35.2 cm wide carcasses resp. behind 34.8 cm wide doors	behind 52.4 cm wide doors and flaps	behind 70.4 cm wide doors and flaps	behind 105.6 cm wide flaps	for ½ compartment behind 140.8 cm wide flaps	for ½ compartment behind 176.0 cm wide flaps	
	for 33.0 cm depth	Price gr. I II III	<b>133</b> - - -						
	for 45.0 cm depth	Price gr. I II III	<b>134</b> - - -	<b>154</b> - - -	<b>174</b> - - -	<b>1104</b> - - -	<b>174</b> - - -	<b>184</b> - - -	

### Lamps

This luminaire contains built-in LED lamps of the energy classes A++ to A. The lamps cannot be changed in the luminaire. 12 V	LED lamps incl. foot switch. A radio remote control is possible for operation (against a surcharge).
 <b>Integrated LED spotlight</b> Ø 7.1 cm; for fitting in units  Later fitting is not possible.	<p>2.9 W</p> <p>7941</p> <p>-</p>

**NEW**

### Radio remote control with change of colour temperature

The lamps are normally operated by an external foot switch. The colour temperature of the LED lamps is cold white if a foot switch is used. A 4-channel radio remote control is also available as an alternative, which is charged extra. Several lamps can be operated with each of the 4 channels. All 4 channels can be dimmed separately at the push of a button. The colour temperature of all 4 channels can be set to any level from cold white (approx. 6500 kelvin = the basic setting of the LED lamps) to warm white (approx. 2700 kelvin). If warm white is required, a radio remote control must be ordered. It is also possible to switch all channels on and off simultaneously with the "all on" or "all off" buttons. The radio remote control consists of one transmitter and one receiver. If several receivers are required because of the arrangement of the units, these and the corresponding cables are provided ex-works (no surcharge). The foot switch is omitted when the radio remote control is used.



**2119**

-



# Special-sized products

## Special heights, special widths, special depths

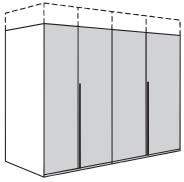

### Special heights

- Hinge-, folding- and sliding-door wardrobes can be reduced in height at intervals of 1.0 cm.
- Below eye-level we recommend fitting a top cover shelf made of panelling material. Please state in order!
- Special heights in stepped versions (not possible on sliding-door wardrobes) at a surcharge.

Surcharge per step:

00030

-

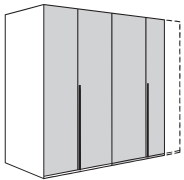

### Special widths

Only applies to hinge- and folding-door wardrobes

- Single-door units, left or right hinges, can be reduced down to 25 cm width (apart from profiled doors).
- Twin-door units can be reduced at both sides down to 50 cm total width (apart from profiled doors).
- Interior fittings such as drawers and other fittings cannot be reduced in width.
- For notes on width reductions on MULTI-FORMA II sliding-door wardrobes please see special-sized products for MULTI-FORMA II!

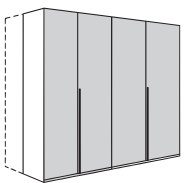

### Special depths

- Depth reductions are made on side sections, plinths, cornices and shelves.
- Interior fittings such as drawers and other fittings cannot be reduced in depth.
- A max. reduction of 30.0 cm is possible on hinge- and folding-door wardrobes.
- A max. reduction of 9.0 cm is possible on profiled hinge-doors.
- For sliding-door wardrobes, a max. reduction of 30.0 cm is possible (max. 18 cm in combination with the electrical opening system for MULTI-FORMA II).
- Please note that for technical production reasons not every special depth can be achieved:  
2.5 cm standard reduction between 0 and 2.5 cm  
5.0 cm standard reduction between 4.5 and 5.0 cm  
27.5 cm standard reduction between 27.0 and 27.5 cm

## Notes on calculating sizes of sloping units

### Side sloping

Sloping is only possible on single-door units. The door hinge (left or right) is positioned on the taller outer side of the unit.

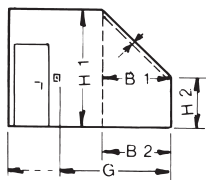
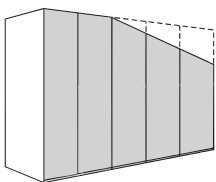

#### Measurements required:

- H 1 = Room height
- H 2 = Height of slope (If a space is required between the wall and the wardrobe/unit, please state the exact distance.)
- B 1 = Width of slope
- B 2 = Width of slope
- G = Total width
- S = Wardrobe width

#### Please note!

- If the slope cuts across the position of a handle, the handle of this door only is positioned further down in production.
- As floors, ceilings and walls are never exactly straight, the exact room size must be measured using a spirit level.
- If a cornice is fitted, please state if this is to be continued in the sloping section.

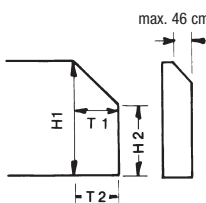
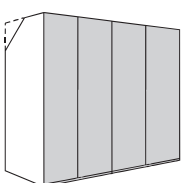

### Rear sloping

Rear sloping is possible on all wardrobe units.

#### Measurements required:

- H 1 = Room height
- H 2 = Height of slope (If a space is required between the wall and the wardrobe/unit, please state the exact distance.)
- T 1 = Depth of slope
- T 2 = Depth of slope

## GENTIS

### Wardrobes

<b>Special heights:</b>			
Hinge-door	- Wood	<b>0003</b>	without surcharge
Hinge-door	- Mirror	<b>00031</b>	without surcharge

<b>Special widths:</b>			
for single-door unit	- Wood	<b>0005</b>	-
for single-door unit	- Mirror	<b>00051</b>	-
for twin-door unit	- Wood	<b>0006</b>	-
for twin-door unit	- Mirror	<b>00061</b>	-

When ordering extra fitted shelves and clothes rods			
Size reduction surcharge per fitted shelf		<b>9991</b>	-
Size reduction surcharge per clothes rod		<b>9992</b>	-

<b>Special depths:</b>			
Surcharge per unit		<b>0007</b>	-

When ordering extra fitted shelves			
Size reduction surcharge per fitted shelf		<b>9993</b>	-

<b>Side sloping:</b>			
Surcharge per unit		<b>9994</b>	-

<b>Rear sloping:</b>			
Surcharge per unit		<b>99912</b>	-

**Special-sized products for special combinations:**  
Pricing: special combination + 15% plus all the required special-sized products (see above)

**More special products are possible.**  
**Please get in touch with your customer advisor.**

## Special articles

Wardrobe doors are also available as separate units and are charged as follows:

**For 1 hinge-door/folding-door wing:** 50% of the concerning 1-door hinge-door extension unit

**For 1 sliding-door including mechanism:** 35% of the twin-door sliding-door wardrobe

For door superstructures, type **100** (max. 98 cm wide, only for assembly between wardrobes): 100% of twin-door hinge-door extension unit

### Cover panels

for side and top panelling of fitted wardrobes (support construction and fitting materials must be acquired on site).

Basic price per order	<b>9901</b>	-
+ price per m <sup>2</sup> in price group I	<b>990</b>	-
+ price per m <sup>2</sup> in price group II	<b>990</b>	-

Veneer match with fronts can not be guaranteed.

### Rim veneer

superimposed ex works or rims lacquered for veneer and lacquer versions per m. length

in price group I	<b>9902</b>	-
in price group II	<b>9902</b>	-

### Individual special-sized products

If the special-sized product that you require is so unusual that it cannot be illustrated with the many special sized products that we already provide and charge for, then we will quote you the price using a HK unit type factor. In your order please state for us the relevant enquiry number and the HK unit type factor stated.

**HK** -

### 165° hinges

Wardrobe doors can also be fitted with **165° hinges** against a surcharge (only possible on plain, straight hinge-doors; impossible on fabric-covered doors and accent fronts). Please mark the doors clearly in the order!

Surcharge for 165° hinges per hinge-door: **180** -

### High-gloss care set

Polish, polishing sponge and polishing cloth (incl. instructions) for protecting and maintaining the high-gloss surfaces **36** -

### Special colours; Note on „Blue Angel“ / Emissions label of DGM

#### Special colours

All the hülsta lacquer colours are possible for nearly all the hülsta ranges. Availability and prices on request.

#### Note on „Blue Angel“ (RAL-UZ 38) and Emissions label of DGM (Class A)

It is possible that the requirements of the „Blue Angel“ and the DGM Emissions Label cannot be met by some of the lacquer colours in price groups II and III (see here the different lacquer versions in the NURIA range), depending on the colour mix (surface ratio of these colours in the corresponding order). However, the legal requirements are definitely met in all cases!

# Switch options for lamps: Radio remote control with change of colour temperature

## Radio remote control with change of colour temperature

The lamps are normally operated by an external foot switch. The colour temperature of the LED lamps is cold white if a foot switch is used. A 4-channel radio remote control is also available as an alternative, which is charged extra. Several lamps can be operated with each of the 4 channels. All 4 channels can be dimmed separately at the push of a button. The colour temperature of all 4 channels can be set to any level from cold white (approx. 6500 kelvin = the basic setting of the LED lamps) to warm white (approx. 2700 kelvin). If warm white is required, a radio remote control must be ordered. It is also possible to switch all channels on and off simultaneously with the "all on" or "all off" buttons. The radio remote control consists of one transmitter and one receiver. If several receivers are required because of the arrangement of the units, these and the corresponding cables are provided ex-works (no surcharge). The foot switch is omitted when the radio remote control is used.

**The following points must be noted with the radio remote control:**

- The receiver must be positioned behind a rear wall or under plinth shelves (at least 20 mm space required under plinth shelves).
- The total wattage power of all lamps included per receiver must not exceed 30 W.
- 4 channels = 4 light groups
- 1 light group = x lights
- All lamps within a light group can be dimmed to the same brightness.
- The change of the colour temperature takes place for all lamps in all light groups.
- The radio remote control is not suitable for equipment operating on 110 V.

**Please be sure to note the operating and programming instructions!**

**4-channel radio remote control with change of color temperature**

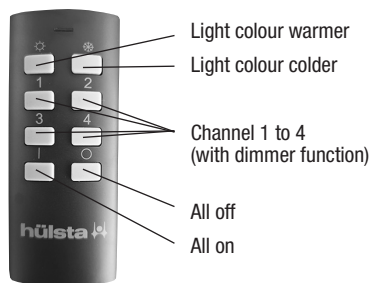

**4-channel radio remote control with change of color temperature**

Type	2119	-
------	------	---

Examples of use (schematic diagrams)

**Example 1**

**Lights inside a unit**

Channel 1 operates (and dims) all the lights in light group 1, i.e. the LED spotlamp in the left cabinet

Channel 2 operates (and dims) all the lights in light group 2, i.e. the LED spotlamps in the open compartment

Channel 3 operates (and dims) all the lights in light group 3, i.e. the LED spotlamp in the right cabinet

**Notes:**

The total wattage power of all lamps included per receiver must not exceed 30 W. The change of the colour temperature takes place for all lamps in all light groups.

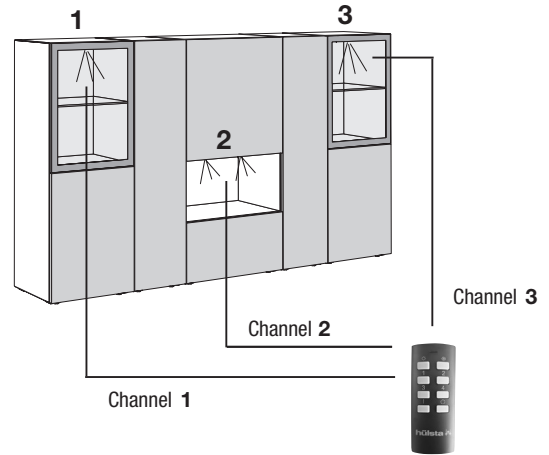

**Example 2**

**Lights in units set apart**

Channel 1 operates (and dims) all the lights in light group 1, i.e. the LED spotlamp and the LED light panels in the left cabinet

Channel 2 operates (and dims) all the lights in light group 2, i.e. the LED spotlamps and the LED light panels in the centre cabinet

Channel 3 operates (and dims) all the lights in light group 3, i.e. the LED spotlamp and the LED light panels in the right cabinet

**Notes:**

The total wattage power of all lamps included per receiver must not exceed 30 W. The change of the colour temperature takes place for all lamps in all light groups.

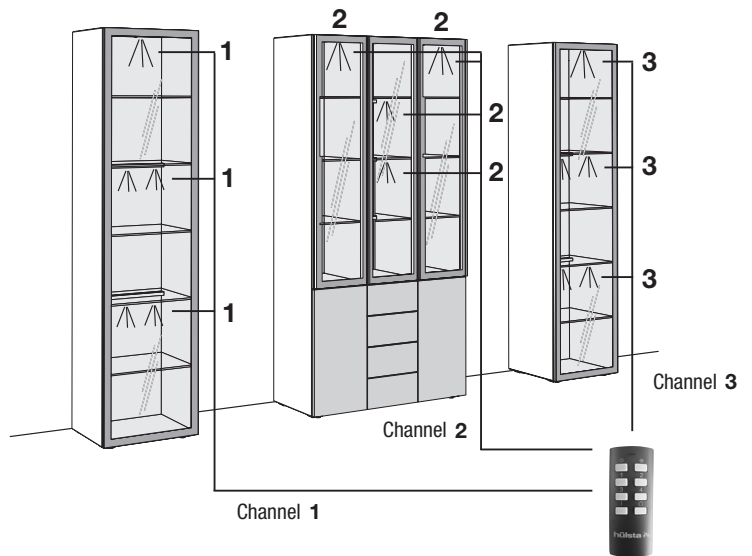

**Example 3**

**Lights in units set apart**

Channel 1 operates (and dims) all the lights in light group 1, i.e. the LED spotlamps in the left, centre and right cabinet

Channel 2 operates (and dims) all the lights in light group 2, i.e. the top LED light panels in the left, centre and right cabinet

Channel 3 operates (and dims) all the lights in light group 3, i.e. the bottom LED light panels in the left, centre and right cabinet

**Notes:**

The total wattage power of all lamps included per receiver must not exceed 30 W. The change of the colour temperature takes place for all lamps in all light groups.

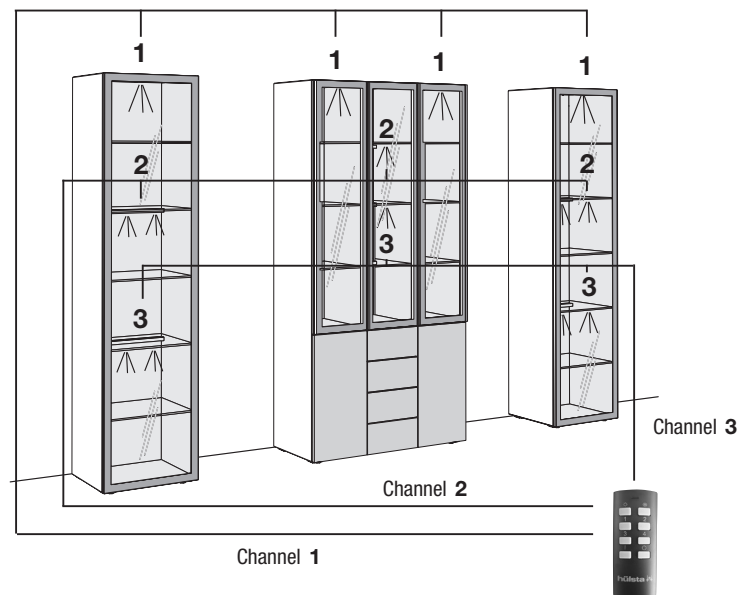



# Usable bed inside height and space under bed

## Note on usable bed inside height:

The support slats of the hülsta beds are delivered in the centre position, i.e. they can be adjusted by 3.2 cm upwards and downwards. If the slats are set in the lowest position, the **maximum usable bed inside height** is achieved.

In the case of some beds, the bed inside height is comparatively low. This means that mattresses in combination with base frames that are somewhat higher are not held so well by the bed side sections. Please note that the usable bed inside height of beds with height adjustable support slats is reduced when these are set higher.

This is how to calculate the individual height from the data supplied with the base frames:

Example: bed and hülstaflex basic B base frame  
(back and foot sections adjustable)

Max. usable bed inside height:  
18.0 cm



approx. 12.5 cm for holding  
mattress

5.5 cm total height of base frame  
(example: hülstaflex basic B)

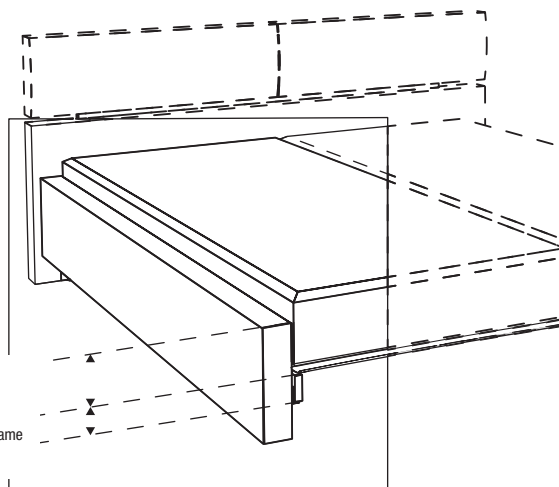

## Note on space under bed:

The storage space underneath the base frame is calculated from the bed height minus the usable bed inside height.

Example bed:  $42.2 \text{ cm} - 18.0 \text{ cm} = 24.2 \text{ cm}$ .



## Wall composition / assembly instruction

**Important notes:**

The composition of walls must be ascertained before concluding a contract and be checked by a qualified fitter before assembly takes place.







Assembly may only be carried out by a qualified fitter under careful observation of the assembly instructions.

The plastic Rawl plugs supplied by hülsta as a standard set are only suitable for concrete  $\geq C12/15$ , if the wall composition and compression strength corresponds to the table below. Under no circumstances must a unit be assembled on light masonry.

Furthermore, we provide a mounting set with assembly mortar for the types of walls listed below (see assembly mortar set below). Again, assembly must be carried out by a qualified fitter under careful observation of the wall composition and assembly instruction. The compression strength levels stated below must be met under all circumstances.

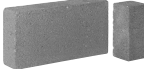
**Materials table**

with a description of which sets are to be used with the following types of walls:

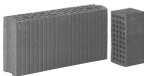
Standard set	Assembly mortar set only suitable for the materials stated below!	
Concrete C12/15 Compression strength $\geq 15 \text{ N/mm}^2$ 	 Building bricks Mz 12 Compression strength $\geq 12 \text{ N/mm}^2$	 Solid blocks of light concrete V2 Compression strength $\geq 2 \text{ N/mm}^2$
	 Limestone blocks KS 12 Compression strength $\geq 12 \text{ N/mm}^2$	 Perforated blocks of light concrete Hbl 2 Compression strength $\geq 2 \text{ N/mm}^2$
	 Perforated sand lime bricks KSL12 Compression strength $\geq 12 \text{ N/mm}^2$	 Aerated concrete PP2 Compression strength $\geq 2 \text{ N/mm}^2$
	 Vertically perforated bricks HLz 12 Compression strength $\geq 12 \text{ N/mm}^2$ Bulk density $\geq 1.0 \text{ kg/dm}^3$	

A different and more suitable type of mounting must be chosen by a qualified fitter in all other cases. hülsta cannot accept any responsibility for the choice of any other types of mounting! Please note that if the units are not mounted properly on the wall, there is a risk of the units falling down or tipping over – especially when alternative mounting materials acquired on site have been used. Generally speaking, you as a dealer/qualified fitter are responsible for the correct wall mounting of the units.



## Mounting sets

**Labelling in type list drawings / assembly notes for wall units**

The majority of units have two wall mounting points (= number of support boards), if these are to be fitted as wall units. This is not explicitly mentioned in the type list. If a different number of wall mounting points (= support boards) is required, this is marked in the drawings in the type list with numbers in black boxes. Every support board requires four mounting screws.

- 3** = 3 support boards
- 4** = 4 support boards, etc.

One **assembly mortar set** is sufficient for up to a maximum of 3 support boards or 4 wall side-panels.

**Important note:** Depending on the composition of the wall (see wall types illustrated above), assembly must be carried out using the special assembly mortar set and a standard trade mastic tool which are the basic essentials for safe and clean workmanship.

**Standard set**

The standard set consists of 4 plastic Rawl plugs and 4 mounting screws and is sufficient for 1 support board. The standard sets are included in the packet of fittings to match the number of support boards.

**Assembly mortar set for up to a maximum of 3 support boards consisting of:**

- 9x injection retaining sleeve
- 9x screw-in sleeve
- 1x injection cartridge
- 2x static mixer
- 1x assembly instructions

Please use the mounting screws from the standard set (supplied free of charge).

**Example of order:**

- Add up number of support boards for all existing unit types
  - Divide the sum by “3”
  - Round up the result to a full number
- = Number of assembly mortar sets required

**M2**

-

## Your Hotline to hülsta

Do you have any questions or require any alterations to your order confirmation?  
Do you have any questions on our products or your current order?  
Do you have any complaints about supplied goods or required replacement parts?  
Contact Telephone: +49 (0) 2563 / 86-1627 • email: orders@huelsta.com

Do you have any questions, suggestions or wishes for the **hülsta product seminars**?  
Contact Telephone: +49 (0) 2563 / 86-1493 • email: produktschulungen@huelsta.de

## hülsta Planning Service

Lots to do? A customer wants his project finished and you haven't got enough time? Or the project is so complex that it will take too much time?

This is exactly the kind of situation we created the hülsta Planning Service for. hülsta's employees create the required project for you at short notice. Based on your information, we implement the project perfectly with all views and a complete order list ready for immediate forwarding to the customer.

The hülsta check list (available at <https://www.huelsta.com/einrichtungsberatung/>) makes it all really easy for you. You won't forget anything with this list and the customer receives a project he will be thrilled about as quickly as possible.

### hülsta Planning Service

Tel.: +49 (0) 2563 / 86-1060

Fax: +49 (0) 2563 / 86-1000

Mail: Planungsservice-Handel@huelsta.de

Workdays from 8.00 a.m. until 6.00 p.m.

## Special wishes? Come to us!

**Maximum individuality! – Maximal flexibility! – hülsta makes most of your special wishes possible.**  
And if you do have a wish which is not quite so easy to implement, just give us a call or send us a mail or a fax. We have our own hülsta "Special Wishes Team" who are there to help you realise just these customer requests. These colleagues are professionals when it comes to special products. They plan and calculate the products possible for you and even develop an alternative suggestion if the idea should turn out to be technically impossible.

### Here is an overview of the hülsta range of special wishes:

- A lot of special products can be ordered simply via the type list
- Special-sized products are planned simply and professionally
- Competent colleagues advise you by phone, by fax and by mail
- You will be sent alternative suggestions if the idea is technically impossible
- Many special-sized products are available without a surcharge
- Specially qualified carpenters and technicians implement your plans perfectly

### hülsta Special Wishes Team

Tel.: +49 (0) 2563 / 86-1060

Fax: +49 (0) 2563 / 86-1417

Mail: Sonderwunsch@huelsta.com

## We are open Saturdays for you, too!

Our **Saturday hotline** is available at the following times and periods:

- **15th April – 15th September** from **10.00 a.m. until 4.00 p.m.**
- **16th September – 14th April** from **10.00 a.m. until 6.00 p.m.**

Telephone: +49 (0) 2563 / 86-1800

On **working days** the hülsta Sales Department is available all day from **8.00 a.m. until 6.00 p.m.**

## hülsta GENTIS Schlafen

Stand: E 12. 2019

Design and concept legally protected, subject to error and alterations to construction, colour and materials by way of technological progress.

hülsta-werke · Karl-Hüls-Straße 1 · D-48703 Stadtlohn  
Tel. +49 (0) 2563 / 86-0 · Fax +49 (0) 2563 / 86-1000  
[www.huelsta.com](http://www.huelsta.com)

**hülsta** 