

Foni

6/19
E

Type list



FONIS

NEW range

Contents

	Page
Range introduction, lists of versions	2-4
Suggested combinations	5-7
Lowboards, sideboards	8-9
Highboards, cabinets	10
Wall units	11
Intermediate bookshelves, top bookshelves, wall shelves	12
Media accessories for lowboards, cable apertures, column system, flat screen supports	14-15
Accessories for units, lamps	16-18
Dining, coffee tables	19
General information:	
Switch options for lamps	20-21
Special-sized products, special articles	22
Important notes: quality of walls / assembly instruction	23

Pieces of art

These expressive soloists, which are both subtle and luxurious, also work perfectly in an ensemble – because they stand out without being overpowering. The cubes from the exclusive FONIS range are tapered into slim frames to create elegant fronts in smooth matt lacquer. The most eye-catching highlight, however, is the delicate frame that supports every unit.

Monumental light-heartedness

Above all, you will love FONIS for its uncompromising design. The elaborate architecture creates entirely new, balanced perspectives using shapes, proportions, colours and materials.

Individual pieces in your favourite colour

Aubergine or cappuccino, steel blue, ochre or silk grey – whichever colour you prefer, we can manufacture individual units in exactly that shade. In addition to standard colours, which are actually not that standard, every imaginable colour from the Natural Colour System is also available.

Soloists in an ensemble

The wide choice of shapes and colours makes it easy to create a stylish interior design with these striking soloists: from a compact living room combination to an airy designer solution featuring sideboards and wall-mounted shelves.

And then there was light and sound

The exclusive FONIS range includes integrated solutions for lighting in open compartments and glass cabinets as well as the operation of electronics concealed within the lowboard: The remote-controlled LED lighting with colour change and the smart IR repeater set provide the finishing touch to this design concept.

Lists of versions

Model no.	Carcase and front	Price group	Model no.	Metal substructure and frame profile	Price group
648	Pure white lacquer	I	173	Quartz structured lacquer	I
641	Grey lacquer	I	172	Anthracite structured lacquer	I
663	Silk grey lacquer	I	131	High-gloss chrome	II
659	Anthracite lacquer	I			
669	Cappuccino lacquer	II			
672	Aubergine lacquer	II			
673	Steel blue lacquer	II			
674	Fir green lacquer	II			
NCS	Free colour choice according to NCS (Natural Colour System)	III			
Free colour choice according to NCS (Natural Colour System) Information on this subject can be found on the following pages.					

Changing versions

Colour combinations within individual units are possible. In this case please state the model number clearly and separately in the order! If versions from different price groups are exchanged, the higher price group is always charged.

Note on „Blue Angel“ (RAL-UZ 38) and Emissions label of DGM (Class A)

It is possible that the requirements of the „Blue Angel“ and the DGM Emissions Label cannot be met by some of the lacquer colours in price groups II and III, depending on the colour mix (surface ratio of these colours in the corresponding order). However, the legal requirements are definitely met in all cases!

Important notes

Glass versions:

Glass fronts, glass shelves behind fronts and glass shelves of bookshelves of clear glass.

Metal substructures, frame profiles:

Metal substructures and frame profiles in quartz structured lacquer, anthracite structured lacquer or high-gloss chrome. Please state the required version clearly in the order! Metal substructures incl. plinth adjusters.

Standard interior fittings:

Fitted wooden shelves are fitted behind doors at 2 Raster intervals and fitted glass shelves are fitted behind glass doors.

Drawer frames in standard grey.

Wall units:

Wall units always incl. wall bracket

Combinations of floor and wall units:

If floor and wall units are combined within an arrangement, there must not be any skirting boards in the room near the floor units, otherwise they must be removed.

Max. load:

Max. load of wooden and glass shelves (up to 70.4 cm width) as well as drawers: 25 kg

Max. load of wooden and glass shelves (between 70.4 and 105.6 cm width): 15 kg;

from 105.6 cm width: 10 kg

Max. load of cover shelves: 35 kg per metre length for floor units. Please also note any maximum loads which may be stated in the type list for the individual units!

hülsta-Push-to-open: Drawers, flaps and doors with hülsta Push-to-open

NCS - the Natural Colour System®©

NCS - the Natural Colour System®© is a logical colour denomination system which is based on how people see colours.

The NCS has defined 1,950 standardised colours in the colour spectrum, basically in steps of ten, and with this system it has symbolised the entire colour spectrum. Every NCS colour sample is visually identical with every other colour sample of the same denomination, regardless of whether it is a standardised colour or a colour which lies somewhere between the 1,950 standard colour samples. Practically any given colour can be described with the NCS system. The 1,950 NCS Standard Colours were so defined as to provide a representative distribution of colours in the colour spectrum.

Note on „Blue Angel“ (RAL-UZ 38) and Emissions label of DGM (Class A)

It is possible that the requirements of the „Blue Angel“ and the DGM Emissions Label cannot be met by some of the lacquer colours in price groups II and III, depending on the colour mix (surface ratio of these colours in the corresponding order). However, the legal requirements are definitely met in all cases!

Information on the sketches

Split drawer frames:

Split drawer frames are used for drawers in front widths of 140.4 cm, 175.6 cm and 210.8 cm (the partitions are shown by dotted lines in the sketches). The front widths of the drawers are illustrated at the sketches of the units so that you can order suitable accessories for the drawers.

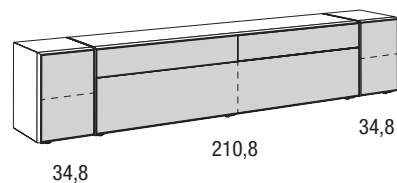

Wall units

If lowboards are included as wall units, a maximum load per unit of 15 kg per metre must not be exceeded for reasons of stability! Max. load 15 kg per metre:

181.8 cm width: 25 kg

217.0 cm width: 30 kg

252.2 cm width: 30 kg

287.4 cm width: 35 kg

The wall units can only be fitted on absolutely solid walls. Light masonry is not suitable for this purpose.

For each project please remember to leave a 2.0 cm gap at the top to be able to mount units.

Range introduction

Labelling in type list drawings / assembly notes for wall units

Labelling in type list drawings / assembly notes for wall units

The majority of units have two wall mounting points (= number of base plates), if these are to be fitted as wall units. This is not explicitly mentioned in the type list. If a different number of wall mounting points (= base plates) is required, this is marked in the drawings in the type list with numbers in black boxes. Please be sure to note here the information and notes in the "Wall composition" chapter!

3

4

Notes on delivery

Notes on delivery:

The majority of the units are delivered standard as **fully connected units (glued)** so that the carcass **cannot be disassembled**. There are however some **exceptions** to this rule:

Some carcasses are delivered as complete units but can be **disassembled into individual sections** in the final customer's home. These types are marked with a **1** in the type list.

1

Some carcasses are delivered **in individual sections** because of their size. These types are marked with a **2** in the type list.

2

The fronts with the number **2** are delivered separately and can therefore always be (dis-) assembled.

Wall fitting

Important notes: Generally speaking, you as a dealer/qualified fitter are responsible for the correct wall mounting of the units. That is why wall mounting should only be carried out by properly trained and qualified fitters. hülsta supplies materials for mounting units on walls for nearly all the units and which should be used for safety and for constructional reasons. The assembly materials supplied by hülsta (plugs, screws) are only suitable for fitting components on to concrete in firmness class C12/15.

For other materials (please see separate materials table in the wall composition chapter) we provide you with an assembly mortar set as an extra order. Please note that this assembly mortar set is also only suitable for the materials listed in the materials table. If walls are made up of other materials (e.g. plastered or lighter wall materials), one should use another method of mounting better suited to the load on site. Please note that if the units are not mounted properly on the wall, there is a risk of the units falling down or tipping over – especially when alternative mounting materials acquired on site have been used. For the reasons stated above it is absolutely essential to enquire about the composition of any walls before signing any contracts.



Suggested combinations

As an alternative to planning an individual unit from the complete range there is the possibility of choosing from specially suggested combinations. This eases planning. Incorporating accessories can enhance the suggested combinations. These are charged extra.

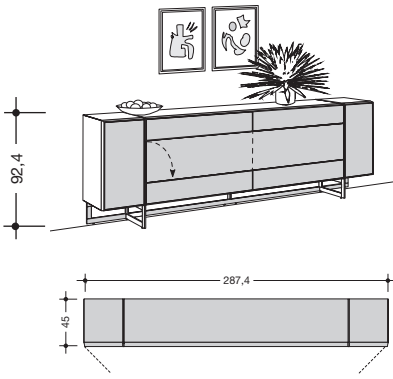
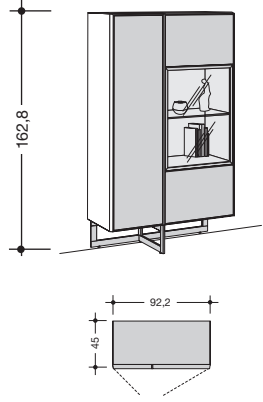
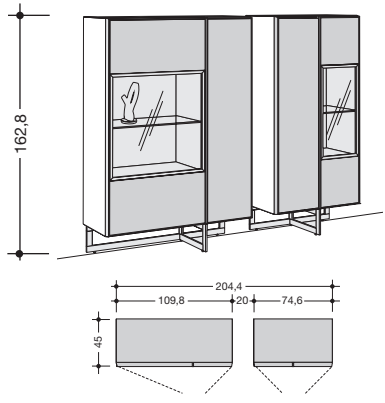
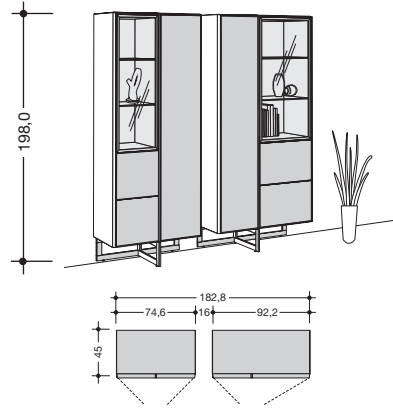
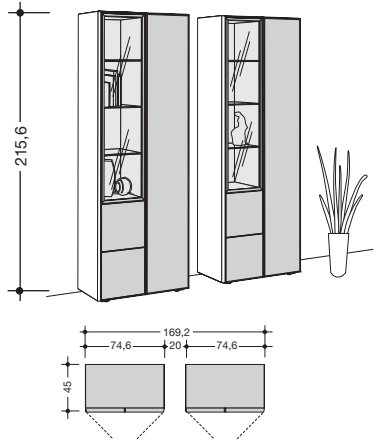
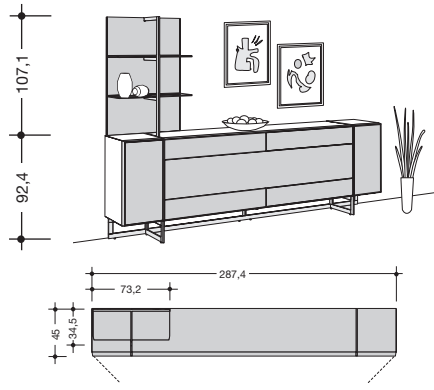
 <p>Surcharge for frame profile and metal substructure in high-gloss chrome -</p>	 <p>Surcharge for frame profile and metal substructure in high-gloss chrome -</p>
<p>as illustr. v. versa Price gr.</p> <p>980006</p> <p>I - II - III -</p>	<p>980013 981013</p> <p>- - -</p>
 <p>Surcharge for frame profile and metal substructure in high-gloss chrome -</p>	 <p>Surcharge for frame profile and metal substructure in high-gloss chrome -</p>
<p>as illustr. v. versa Price gr.</p> <p>980002 981002</p> <p>I - II - III -</p>	<p>980007 981007</p> <p>- - -</p>
 <p>Surcharge for frame profile in high-gloss chrome -</p>	 <p>Surcharge for frame profile and metal substructure in high-gloss chrome -</p>
<p>Price gr.</p> <p>980009 981009</p> <p>- - -</p>	<p>980012 981012</p> <p>- - -</p>

Suggested combinations

As an alternative to planning an individual unit from the complete range there is the possibility of choosing from specially suggested combinations. This eases planning. Incorporating accessories can enhance the suggested combinations. These are charged extra.

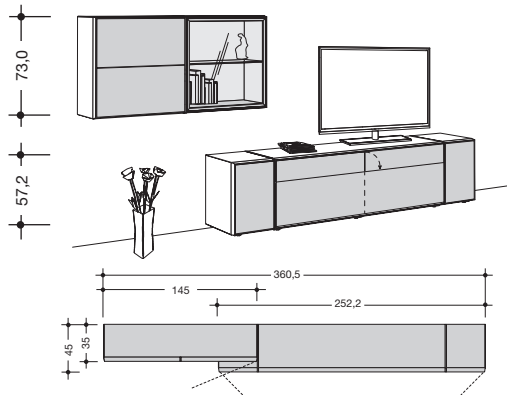

Surcharge for frame profile in high-gloss chrome -

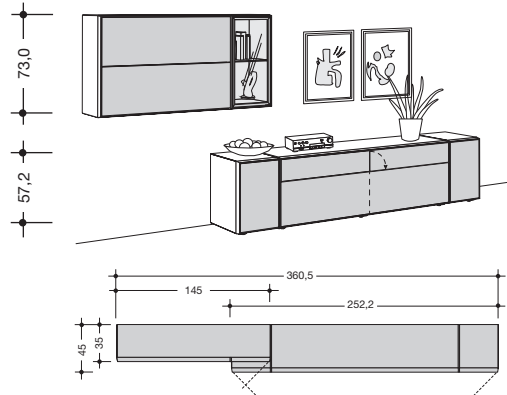

Surcharge for frame profile in high-gloss chrome -

as illustr.
v. versa
Price gr.
I
II
III

980014
981014

-
-
-

980015
981015

-
-
-

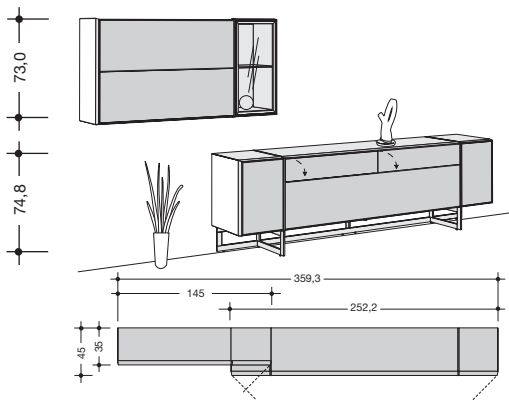

Surcharge for frame profile and metal substructure in high-gloss chrome -

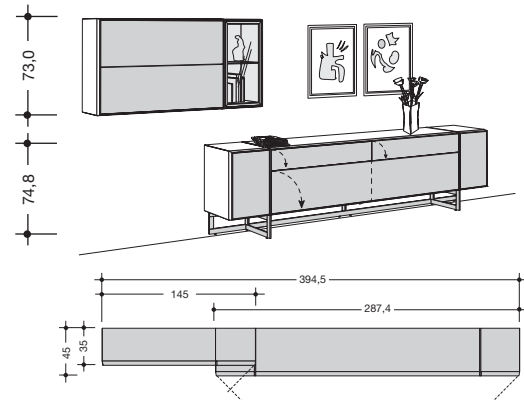

Surcharge for frame profile and metal substructure in high-gloss chrome -

as illustr.
v. versa
Price gr.
I
II
III

980003
981003

-
-
-

980010
981010

-
-
-

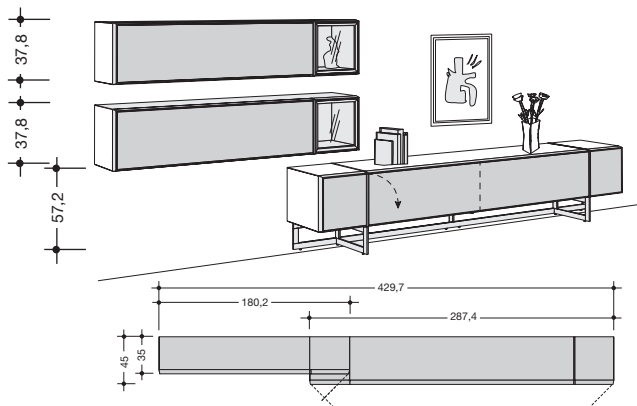

Surcharge for frame profile and metal substructure in high-gloss chrome -

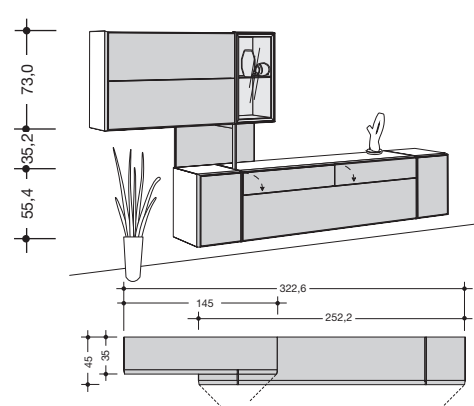

Surcharge for frame profile in high-gloss chrome -

as illustr.
v. versa
Price gr.
I
II
III

980004
981004

-
-
-

980001
981001



-
-
-

Suggested combinations

As an alternative to planning an individual unit from the complete range there is the possibility of choosing from specially suggested combinations. This eases planning. Incorporating accessories can enhance the suggested combinations. These are charged extra.

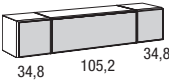
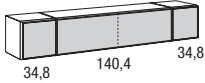
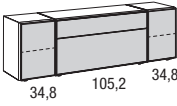
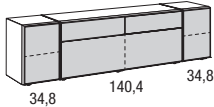
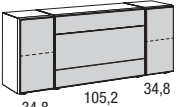
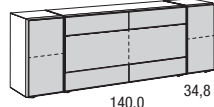

<p>Surcharge for frame profile in high-gloss chrome -</p>	<p>Surcharge for frame profile in high-gloss chrome -</p>	
<p>as illustr. v. versa Price gr.</p>	<p>980011 981011</p>	<p>980005 981005</p>
<p>I II III</p>	<p>- - -</p>	<p>- - -</p>

Lowboards and sideboards





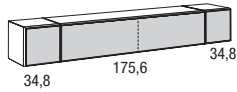
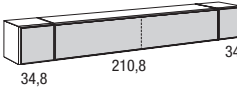
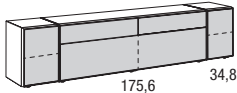
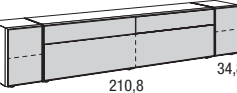
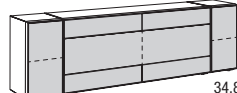
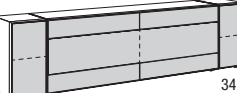

Lowboards 37.8 cm high (39.6 cm high incl. 1.8 cm high plinth adjusters), 45.0 cm deep	Surcharge for frame profile in high-gloss chrome -						
	 34,8 105,2 34,8 181.8 cm wide			 34,8 140,4 34,8 217.0 cm wide			
	Flap hinge at bottom		1 door; 1 drawer; 1 door	1 door; 1 flap; 1 door	1 door; 1 drawer; 1 door	1 door; 1 flap; 1 door	
		21811	21818	22111	22118		
	Price gr.	-	-	-	-		
	I	-	-	-	-		
	II	-	-	-	-		
	III	-	-	-	-		
When used as wall units: Max. load: 40 kg							
Lowboards 55.4 cm high (57.2 cm high incl. 1.8 cm high plinth adjusters), 45.0 cm deep	Surcharge for frame profile in high-gloss chrome -						
	 34,8 105,2 34,8 181.8 cm wide			 34,8 140,4 34,8 217.0 cm wide			
	Flap hinge at bottom		Left: 1 door Centre: 1 flap Right: 1 door	Left: 1 door Centre: 1 drawer Right: 1 door	Left: 1 door Centre: 2 flaps Right: 1 door	Left: 1 door Centre: 1 drawer, 1 flap Right: 1 door	Left: 1 door Centre: 1 flap, 1 drawer Right: 1 door
		31828	31818	32128	32138	32148	32118
	Price gr.	-	-	-	-	-	-
	I	-	-	-	-	-	-
	II	-	-	-	-	-	-
	III	-	-	-	-	-	-
When used as wall units: Max. load: 40 kg							
Sideboards 73.0 cm high (74.8 cm high incl. 1.8 cm high plinth adjusters), 45.0 cm deep	Surcharge for frame profile in high-gloss chrome -						
	 34,8 105,2 34,8 181.8 cm wide			 34,8 140,0 34,8 217.0 cm wide			
	Flap hinge at bottom		Left: 1 door Centre: 1 flap; 1 drawer Right: 1 door	Left: 1 door Centre: 1 drawer; 1 drawer Right: 1 door	Left: 1 door Centre: 2 flaps; 2 drawers Right: 1 door	Left: 1 door Centre: 1 drawer, 1 flap; 2 drawers Right: 1 door	Left: 1 door Centre: 1 flap, 1 drawer; 2 drawers Right: 1 door
		41828	41818	42128	42138	42148	42118
	Price gr.	-	-	-	-	-	-
	I	-	-	-	-	-	-
	II	-	-	-	-	-	-
	III	-	-	-	-	-	-
When used as wall units: Max. load: 40 kg							
Metal substructure incl. plinth adjusters; 19.4 cm high The units can be planned optionally on a metal substructure. In this case the plinth adjusters are omitted.	 for 181.8 cm width			 for 217.0 cm width			
			2181	2211			
		Price gr.	-	-			
	I	-	-				
	II	-	-				
When used as wall units: Max. load: 40 kg							
Wall bracket: If units are to be included as wall units or stacked on top of one another, a wall bracket must be ordered.		2183	2213				
		-	-				

Notes on delivery:
Please see here the information on range introduction pages.

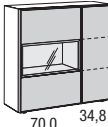
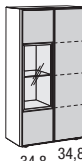
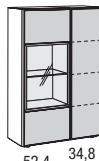
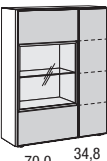

Assembly notes for wall units:
Please be sure to note here the information and notes in the "Wall composition" chapter!

Surcharge for frame profile in high-gloss chrome -									
 34,8 175,6 34,8 252.2 cm wide					 34,8 210,8 34,8 287.4 cm wide				
Flap hinge at bottom		1 door; 1 drawer; 1 door	1 door; 1 flap; 1 door	1 door; 1 drawer; 1 door	1 door; 1 flap; 1 door				
		22511	22518	22811	22818				
	Price gr.	-	-	-	-				
	I	-	-	-	-				
	II	-	-	-	-				
	III	-	-	-	-				
Surcharge for frame profile in high-gloss chrome -									
 34,8 175,6 34,8 252.2 cm wide					 34,8 210,8 34,8 287.4 cm wide				
Flap hinge at bottom		Left: 1 door Centre: 2 flaps Right: 1 door	Left: 1 door Centre: 1 drawer, 1 flap Right: 1 door	Left: 1 door Centre: 1 flap, 1 drawer Right: 1 door	Left: 1 door Centre: 2 drawers Right: 1 door	Left: 1 door Centre: 2 flaps Right: 1 door	Left: 1 door Centre: 1 drawer, 1 flap Right: 1 door	Left: 1 door Centre: 1 flap, 1 drawer Right: 1 door	Left: 1 door Centre: 2 drawers Right: 1 door
		32528	32538	32548	32518	32828	32838	32848	32818
	Centre below: Flap	Price gr.	-	-	-	-	-	-	-
		I	-	-	-	-	-	-	-
		II	-	-	-	-	-	-	-
		III	-	-	-	-	-	-	-
	Centre below: Drawer	Price gr.	32521	32531	32541	32511	32821	32831	32811
		I	-	-	-	-	-	-	-
		II	-	-	-	-	-	-	-
		III	-	-	-	-	-	-	-
Surcharge for frame profile in high-gloss chrome -									
 34,8 175,6 34,8 252.2 cm wide					 34,8 210,8 34,8 287.4 cm wide				
Flap hinge at bottom		Left: 1 door Centre: 2 flaps; 2 drawers Right: 1 door	Left: 1 door Centre: 1 drawer, 1 flap; 2 drawers Right: 1 door	Left: 1 door Centre: 1 flap, 1 drawer; 2 drawers Right: 1 door	Left: 1 door Centre: 2 drawers; 2 drawers Right: 1 door	Left: 1 door Centre: 2 flaps; 2 drawers Right: 1 door	Left: 1 door Centre: 1 drawer, 1 flap; 2 drawers Right: 1 door	Left: 1 door Centre: 1 flap, 1 drawer; 2 drawers Right: 1 door	Left: 1 door Centre: 2 drawers; 2 drawers Right: 1 door
		42528	42538	42548	42518	42828	42838	42848	42818
	Centre: Flap	Price gr.	-	-	-	-	-	-	-
		I	-	-	-	-	-	-	-
		II	-	-	-	-	-	-	-
		III	-	-	-	-	-	-	-
	Centre: Drawer	Price gr.	42521	42531	42541	42511	42821	42831	42811
		I	-	-	-	-	-	-	-
		II	-	-	-	-	-	-	-
		III	-	-	-	-	-	-	-
 for 252.2 cm width					 for 287.4 cm width				
		2251				2281			
	Price gr.	-				-			
	I	-				-			
	II	-				-			
		2253				2283			
		-				-			

Highboards

Highboards 108.2 resp. 143.4 cm high (110.0 resp. 145.2 cm high incl. 1.8 cm high plinth adjusters), 45.0 cm deep Cannot be fitted as a wall unit!	108.2 cm high Surcharge for frame profile in high-gloss chrome -		143.4 cm high Surcharge for frame profile in high-gloss chrome -		
	 70,0 34,8 109.8 cm wide		 34,8 34,8 74.6 cm wide	 52,4 34,8 92.2 cm wide	 70,0 34,8 109.8 cm wide
		Left: 1 door with glass section Right: 1 door	Left: 1 door with glass section Right: 1 door	Left: 1 door with glass section Right: 1 door	Left: 1 door with glass section Right: 1 door
	as illustr. v. versa Price gr. I II III	71121 71122 - - -	97511 97512 - - -	99211 99212 - - -	91111 91112 - - -
Metal substructure incl. plinth adjusters; 54.6 resp. 19.4 cm high The units can be planned optionally on a metal substructure. In this case the plinth adjusters are omitted.	54.6 cm high  19.4 cm high  for 109.8 cm width	19.4 cm high  for 74.6 cm width	19.4 cm high  for 92.2 cm width	19.4 cm high  for 109.8 cm width	
	Price gr. I II	3111 - -	2111 - -	271 - -	291 - -

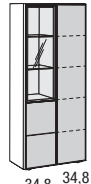
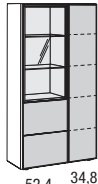
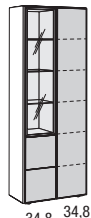
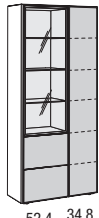

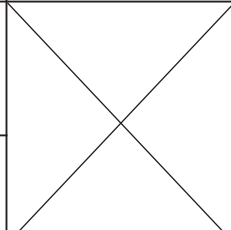
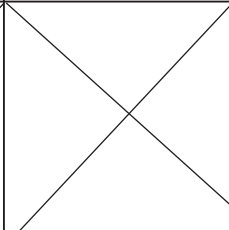

Cabinets

Cabinets 178.6 resp. 213.8 cm high (180.4 resp. 215.6 cm high incl. 1.8 cm high plinth adjusters), 45.0 cm deep Cannot be fitted as a wall unit! Cannot be fitted on a metal substructure in 213.8 cm height!	178.6 cm high Surcharge for frame profile in high-gloss chrome -		213.8 cm high Surcharge for frame profile in high-gloss chrome -		
	 34,8 34,8 74.6 cm wide		 52,4 34,8 92.2 cm wide	 34,8 34,8 74.6 cm wide	 52,4 34,8 92.2 cm wide
		Left: 1 glass door, 2 drawers Right: 1 door	Left: 1 glass door, 2 drawers Right: 1 door	Left: 1 glass door, 2 drawers Right: 1 door	Left: 1 glass door, 2 drawers Right: 1 door
	as illustr. v. versa Price gr. I II III	117511 117512 - - -	119211 119212 - - -	127511 127512 - - -	129211 129212 - - -
Metal substructure incl. plinth adjusters; 19.4 cm high The units can be planned optionally on a metal substructure. In this case the plinth adjusters are omitted.	 for 74.6 cm width	 for 92.2 cm width			
	Price gr. I II	271 - -	291 - -		

Notes on delivery:
Please see here the information on range introduction pages.

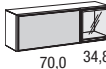
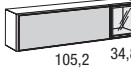
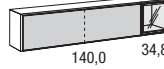
Assembly notes for wall units:
Please be sure to note here the information and notes in the "Wall composition" chapter!

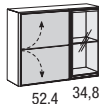
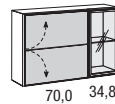
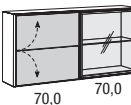
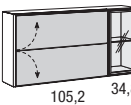
Wall units

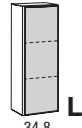
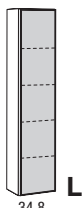
<p>Wall units 37.8 cm high; 35.0 cm deep</p> <p>Max. load: 40 kg</p>	Surcharge for frame profile in high-gloss chrome -					
	 70,0 34,8 109.8 cm wide		 105,2 34,8 145.0 cm wide		 140,0 34,8 180.2 cm wide	
	Flap hinge at bottom	1 drawer; 1 glass door	1 flap; 1 glass door	1 drawer; 1 glass door	1 flap; 1 glass door	1 drawer; 1 glass door
as illustr. v. versa	210111	210181	214111	214181	218111	218181
Price gr.	210112	210182	214112	214182	218112	218182
I	-	-	-	-	-	-
II	-	-	-	-	-	-
III	-	-	-	-	-	-
<p>Wall units or wall assembly: See here the information on page 3</p>						
<p>Wall units 73.0 cm high; 35.0 cm deep</p> <p>Max. load: 40 kg</p>	Surcharge for frame profile in high-gloss chrome -					
	 34,8 34,8 74.6 cm wide		 52,4 34,8 92.2 cm wide		 70,0 34,8 109.8 cm wide	
		1 door; 1 glass door	2 flaps; 1 glass door	2 flaps; 1 glass door		
as illustr. v. versa	47181	410281	410282	410181	410182	
Price gr.	47182					
I	-	-	-	-	-	-
II	-	-	-	-	-	-
III	-	-	-	-	-	-
<p>Max. load: 40 kg</p>	Surcharge for frame profile in high-gloss chrome -					
	 70,0 70,0 145.0 cm wide		 105,2 34,8 145.0 cm wide			
		2 flaps; 1 glass door	2 flaps; 1 glass door			
as illustr. v. versa	414281	414181	414182			
Price gr.	414282					
I	-	-	-	-	-	-
II	-	-	-	-	-	-
III	-	-	-	-	-	-
<p>Wall units or wall assembly: See here the information on page 3</p>						
<p>Wall units 73.0; 108.2 resp. 178.6 cm high; 35.0 cm deep</p> <p>Max. load: 40 kg</p>	73.0 cm high		108.2 cm high		178.6 cm high	
	 34,8 37.8 cm wide		 34,8 37.8 cm wide		 34,8 37.8 cm wide	
		1 door	1 door	1 door		
Price gr.	4311 L	6311 L	10311 L	4312 R	6312 R	10312 R
I	-	-	-	-	-	-
II	-	-	-	-	-	-
III	-	-	-	-	-	-
<p>Wall units or wall assembly: See here the information on page 3</p>						

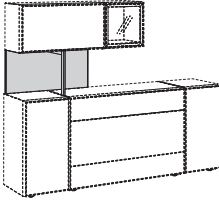
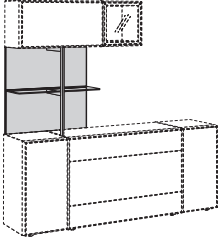

Intermediate bookshelves

Intermediate bookshelves 35.2 resp. 71.1 cm high; 35.0 cm deep with frame profile	35.2 cm high Surcharge for frame profile in high-gloss chrome - 	71.1 cm high; with 1 glass shelf Surcharge for frame profile in high-gloss chrome - 
	73.2 cm wide 2701 - - -	73.2 cm wide 4701 - - -
LED frame profile lamp see page 17	Price gr. I II III	

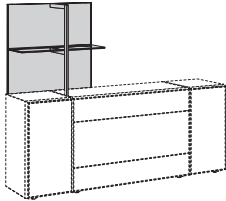
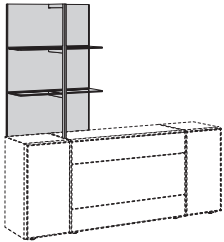
Top bookshelves

Top bookshelves 71.1 resp. 107.1 cm high; 35.0 cm deep with frame profile	71.1 cm high; with 1 glass shelf Surcharge for frame profile in high-gloss chrome - 	107.1 cm high; with 2 glass shelves Surcharge for frame profile in high-gloss chrome - 
	73.2 cm wide 4711 - - -	73.2 cm wide 6711 - - -
LED frame profile lamp see page 17	Price gr. I II III	

Wall shelves

Wall shelves 2.5 cm thick; 24.0 cm deep for fitting anywhere on walls				
	146.6 cm wide	181.8 cm wide	217.0 cm wide	252.2 cm wide
	Max. load: 10 kg	Max. load: 10 kg	Max. load: 15 kg	Max. load: 15 kg
Price gr. I II III	1424	1824	2124	2524
	-	-	-	-
	-	-	-	-
This luminaire contains built-in LED lamps of the energy classes A++ to A. The lamps cannot be changed in the luminaire. 12 V		LED lamps incl. footswitch. A remote control unit is possible for operation (against a surcharge).		
LED lamps for wall shelves				
	for 146.6 cm width	for 181.8 cm width	for 217.0 cm width	for 252.2 cm width
	10.1 W	13.4 W	16.8 W	20.4 W
	145	175	215	245
	-	-	-	-



Media accessories for lowboards

IR repeater set

IR repeater set

Infrared signal transmission set for operating media units behind wooden/lacquered fronts. You can operate all the units in one compartment with one set. The following applies:

- One set must be used in each compartment. 2 transmitters can also be installed in large compartments in order to increase performance. In this case only one additional transmitter needs to be ordered.
- The transmitter must be placed in the direct vicinity of the receiver eye.
- Transmittable IR frequency band 20 – 60 kHz
- Up to 3 transmitters can be combined with one receiver.

It is possible to use 3 transmitters via 1 receiver including Master box. This enables simultaneous operation of 3 different furniture compartments or in critical situations it allows fitting out one furniture compartment with several transmitters in order to increase the performance in this compartment or to operate 2 end units placed next to one another.

The IR repeater set consists of:

- 1 receiver eye (Ø 3.0 cm) incl. standing bracket
- 1 electrical transmitter
- 1 plug EVG 12 V
- Cable clips

Please note the details stated in the operating instructions!

IR repeater set
1 receiver eye and 1 transmitter incl. standing bracket

2001

-

Extra transmitter

2003

-

Cable apertures

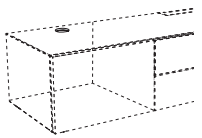

Cable aperture K1

silver-coloured; Ø 8.0 cm;

It is possible to fit a cable aperture in the top shelf of the lowboard. The cable aperture can be made at the rear of the top shelf. The position is in the centre of the compartment, distance from centre of aperture to rear edge of unit: 10.0 cm.

K1

-

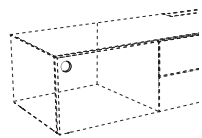

Cable aperture K2

silver-coloured; Ø 8.0 cm;

It is possible to fit a cable aperture in the rear wall of the lowboard. Positioned at centre of compartment.

K2

-

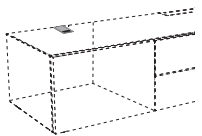

Cable aperture K7

silver-coloured; 7.0 x 12.0 cm;

It is possible to fit a cable aperture in the top shelf of the lowboard. The position is in the centre of the compartment, flush with the rear edge of the unit.

K7

-

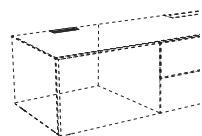

Cable aperture K8

silver-coloured; 12.8 x 3.2 cm;

It is possible to fit a cable aperture in the top shelf of the lowboard. The cable aperture can be made at the rear rim of the top shelf. Positioned in centre of compartment.

K8

-

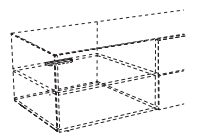

Cable aperture K9

13.0 x 1.6 cm;

It is possible to fit a cable aperture in a fitted shelf. The cable aperture can be made at the rear rim of the fitted shelf. Positioned in centre of compartment.

K9

-

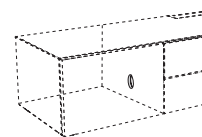

Cable aperture K20





silver-coloured; Ø 8.0 cm;

It is possible to fit a cable aperture in the partitions of the lowboard.

K20

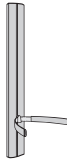

-

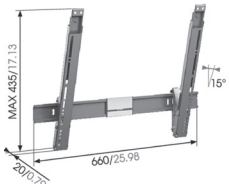
Column system, flat screen supports



<p>Column system consisting of a metal column (for fitting anywhere on wall) and of audio/DVD support(s), for fitting anywhere on column.</p> <p>Example of use:</p> 	<p>Columns of metal; for fitting anywhere on walls above top rim of plinth slot; cables can be laid and hidden at any height; audio/DVD supports can be fitted anywhere on the column.</p>  <table border="1" data-bbox="574 551 1050 668"> <tr> <td>36.8 cm high</td> <td>64.1 cm high</td> </tr> <tr> <td>9201</td> <td>9202</td> </tr> <tr> <td>-</td> <td>-</td> </tr> </table>	36.8 cm high	64.1 cm high	9201	9202	-	-	<p>Audio/DVD support of metal; can be positioned at any height on the column and be adjusted to suit audio/DVD players of any size; with rubber padding at front to prevent units from slipping; max. load: 10 kg</p>  <p>9203</p> <p>-</p>
36.8 cm high	64.1 cm high							
9201	9202							
-	-							
<p>Flat screen support WTL6 The flat screen support can be adjusted 3-dimensionally. It is suitable for flat screens with a screen diagonal of 102-216 cm (40"-85"); max. load: 45 kg. Suitable for Curved TV's. Flat screen support compatible with VESA Norm standard: min.: 200 x 200 mm max.: 600 x 400 mm</p> 	<p>Flat screen support THIN 345, ideally adaptable The flat screen support can be adjusted 3-dimensionally. It is suitable for flat screens with a screen diagonal of 81-140 cm (32"-55") and a maximum depth of 4.5 cm; max. load: 25 kg. Go to www.vogels.com to check if your flat screen can be fitted on this flat screen support. Enter the name THIN 345. After a few steps you can see if your flat screen TV is compatible with the flat screen support. Not suitable for Curved TV's. Flat screen support compatible with VESA Norm standard: min.: 100 x 100 mm max.: 600 x 400 mm</p> 	<p>Flat screen support THIN 315 The flat screen support can be angled up to a max. 15°. It is suitable for flat screens with a screen diagonal of 102-165 cm (40"-65") and a maximum depth of 5.0 cm; max. load: 25 kg. Go to www.vogels.com to check if your flat screen can be fitted on this flat screen support. Enter the name THIN 315. After a few steps you can see if your flat screen TV is compatible with the flat screen support. Not suitable for Curved TV's. Flat screen support compatible with VESA Norm standard: min.: 100 x 100 mm max.: 600 x 400 mm</p> 						
<p>for fitting anywhere on walls</p>	<p>for fitting anywhere on walls</p>	<p>for fitting anywhere on walls</p>						
<p>9704</p> <p>-</p>	<p>9304</p> <p>-</p>	<p>9504</p> <p>-</p>						

Accessories for units

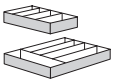
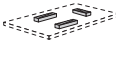
Accessories for drawers



 <p>Tableau lined with grey fabric</p>		for 34.8 cm front width	for 52.4 cm front width	for 70.0 cm front width	for 105.2 cm front width	for ½ drawer, 140.4 cm wide, and 70.0 cm front width	for ½ drawer, 175.6 cm wide, and 87.6 cm front width	for ½ drawer, 210.8 cm wide
	for 35.0 cm depth				8627 -	8628 -	8629 -	
	for 45.0 cm depth	8620 -	8621 -		8623 -	8624 -	8625 -	8626 -
 <p>CD holder for drawers Please state exactly in your order and drawing in which 2 Raster drawer the CD holder is to be fitted.</p>	for 35.0 cm depth			for 60 CD's 8427 -	for 84 CD's 8428 -	for 60 CD's 8429 -		
	for 45.0 cm depth	for 36 CD's 8420 -	for 54 CD's 8421 -		for 126 CD's 8423 -	for 72 CD's 8424 -	for 108 CD's 8425 -	for 126 CD's 8426 -
 <p>DVD/Blu-Ray holder for drawers Please state exactly in your order and drawing in which 2 Raster drawer the DVD/Blu-Ray holder is to be fitted.</p>	for 35.0 cm depth			for 24 DVD's 8327 -	for 40 DVD's 8328 -	for 24 DVD's 8329 -		
	for 45.0 cm depth	for 12 DVD's 8320 -	for 24 DVD's 8321 -		for 60 DVD's 8323 -	for 36 DVD's 8324 -	for 48 DVD's 8325 -	for 60 DVD's 8326 -
 <p>Cutlery box of metal, lined with grey fabric inside; incl. compartments</p>	17.6 cm wide			35.2 cm wide				
	855 -			856 -				
 <p>Cutlery holder lined with grey fabric, for fitting in drawers Set 1: for 60 pieces of cutlery Set 2: for 17 serving utensils</p>	Set 1: for standard cutlery like spoons, forks, knives, etc.			Set 2: for sauce ladles, cake forks, cake servers, etc.				
	116 -			117 -				

Fitted shelves

			for 34.8 cm front width	for 52.4 cm front width	for 70.0 cm front width	for 105.2 cm front width	for ½ compartment behind 140.4 cm wide flaps	for ½ compartment behind 175.6 cm wide flaps	for ½ compartment behind 210.8 cm wide flaps
 <p>Fitted shelf 1.9 cm thick (2.8 cm thick for 105.2 and 210.8 cm front width)</p>	for 35.0 cm depth	Price gr. I II III	144 - -	152 - -	162 - -	1102 - -	172 - -		
	for 45.0 cm depth	Price gr. I II III	134 - -	164 - -	174 - -	1103 - -	163 - -	183 - -	1113 - -
	for wall units type 47181 and 47182	Price gr. I II III	154 - -						
 <p>Glass shelf (clear glass) 0.8 cm thick</p>	for 35.0 cm depth		324 -		364 -				
	for 45.0 cm depth		334 -	354 -	374 -				

Accessories for units

Lamps

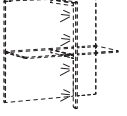
This luminaire contains built-in LED lamps of the energy classes A++ to A. The lamps cannot be changed in the luminaire. 12 V		LED lamps incl. footswitch. A remote control unit is possible for operation (against a surcharge).		
 <p>Integrated LED spotlight Ø 7.1 cm; for fitting in units Later fitting is not possible.</p>	2.9 W			
	7941			
 <p>LED light panel 1.9 cm thick, 3.0 cm deep; for fitting under glass shelves Later fitting is not possible.</p>	for 35.2 cm width	for 52.8 cm width	for 70.4 cm width	
	2.4 W	3.5 W	5.1 W	
325		525	825	
 <p>LED frame profile lamp LED lamp fitted in the frame profile of intermediate and top bookshelves Later fitting is not possible.</p>	for intermediate bookshelf type 2701	for intermediate bookshelf type 4701 and top bookshelf type 4711	for top bookshelf type 6711	
	6.8 W	13.5 W	20.2 W	
725		745	765	

Radio remote control with change of colour temperature

The lamps are normally operated by an external foot switch. The colour temperature of the LED lamps is cold white if a foot switch is used. A 4-channel radio remote control is also available as an alternative, which is charged extra. Several lamps can be operated with each of the 4 channels. All 4 channels can be dimmed separately at the push of a button. The colour temperature of all 4 channels can be set to any level from cold white (approx. 6500 kelvin = the basic setting of the LED lamps) to warm white (approx. 2700 kelvin). If warm white is required, a radio remote control must be ordered. It is also possible to switch all channels on and off simultaneously with the "all on" or "all off" buttons. The radio remote control consists of one transmitter and one receiver. If several receivers are required because of the arrangement of the units, these and the corresponding cables are provided ex-works (no surcharge). The foot switch is omitted when the radio remote control is used.



2119

DINING

hülsta offers a room concept to meet all requirements in comfort, beauty of form and attractiveness with a comprehensive collection of dining room tables and chairs.

The **dining tables** in a wide variety of sizes (with and without pullout function) in all wood surface versions and in contemporary designs, as well as the **dining chairs** that can be combined individually using different armrests, comfort features, high-grade cover fabrics (leather, textiles) and metal surfaces can all be found in the **"DINING"** type list.



Coffee tables / ancillary table CT 250

Coffee tables / ancillary table CT 250

The CT 250 provides genuine designer pieces for your living room. Experience a glass coffee table that features two table tops, thus providing ample storage. Its elegant gloss chrome or powder-coated frame perfectly encases the table tops. Simply combine it with the CT 250 ancillary table, a matching, higher companion for the coffee table. Its expressive frame repeats the round design shape of the table top, perfectly underlining it.

You will find the coffee table CT 250 as well as other coffee tables in the **"Coffee tables"** type list.



Coffee tables

Coffee tables

hülsta offers a comprehensive **collection of coffee tables**, which not only match the hülsta furniture ranges perfectly but can also be combined with other products that are available on the market. You will find these coffee tables in a number of designs, sizes and versions in the **"Coffee tables"** type list.



Switch options for lamps: Radio remote control with change of colour temperature

Radio remote control with change of colour temperature

The lamps are normally operated by an external foot switch. The colour temperature of the LED lamps is cold white if a foot switch is used. A 4-channel radio remote control is also available as an alternative, which is charged extra. Several lamps can be operated with each of the 4 channels. All 4 channels can be dimmed separately at the push of a button. The colour temperature of all 4 channels can be set to any level from cold white (approx. 6500 kelvin = the basic setting of the LED lamps) to warm white (approx. 2700 kelvin). If warm white is required, a radio remote control must be ordered. It is also possible to switch all channels on and off simultaneously with the "all on" or "all off" buttons. The radio remote control consists of one transmitter and one receiver. If several receivers are required because of the arrangement of the units, these and the corresponding cables are provided ex-works (no surcharge). The foot switch is omitted when the radio remote control is used.

The following points must be noted with the radio remote control:

- The receiver must be positioned behind a rear wall or under plinth shelves (at least 20 mm space required under plinth shelves).
- The total wattage power of all lamps included per receiver must not exceed 30 W.
- 4 channels = 4 light groups
- 1 light group = x lights
- All lamps within a light group can be dimmed to the same brightness.
- The change of the colour temperature takes place for all lamps in all light groups.
- The radio remote control is not suitable for equipment operating on 110 V.

Please be sure to note the operating and programming instructions!

4-channel radio remote control with change of color temperature



4-channel radio remote control with change of color temperature

Type	2119	-
------	------	---

Examples of use (schematic diagrams)

Example 1

Lights inside a unit

Channel 1 operates (and dims) all the lights in light group 1, i.e. the LED spotlamp in the left cabinet

Channel 2 operates (and dims) all the lights in light group 2, i.e. the LED spotlamps in the open compartment

Channel 3 operates (and dims) all the lights in light group 3, i.e. the LED spotlamp in the right cabinet

Notes:

The total wattage power of all lamps included per receiver must not exceed 30 W. The change of the colour temperature takes place for all lamps in all light groups.

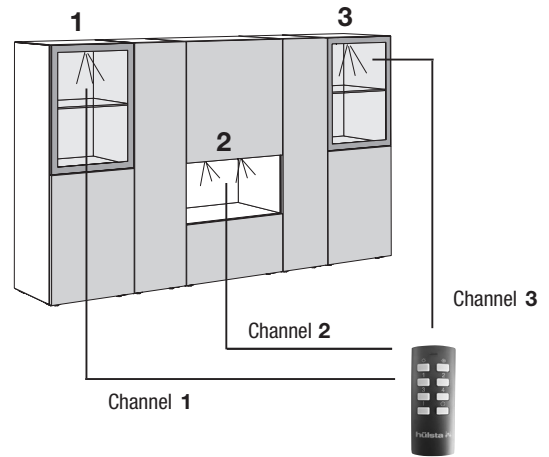

Example 2

Lights in units set apart

Channel 1 operates (and dims) all the lights in light group 1, i.e. the LED spotlamp and the LED light panels in the left cabinet

Channel 2 operates (and dims) all the lights in light group 2, i.e. the LED spotlamps and the LED light panels in the centre cabinet

Channel 3 operates (and dims) all the lights in light group 3, i.e. the LED spotlamp and the LED light panels in the right cabinet

Notes:

The total wattage power of all lamps included per receiver must not exceed 30 W. The change of the colour temperature takes place for all lamps in all light groups.

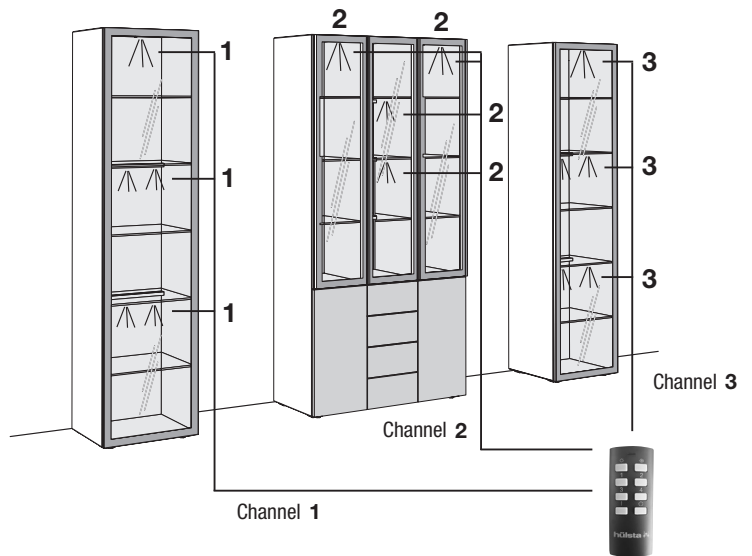

Example 3

Lights in units set apart

Channel 1 operates (and dims) all the lights in light group 1, i.e. the LED spotlamps in the left, centre and right cabinet

Channel 2 operates (and dims) all the lights in light group 2, i.e. the top LED light panels in the left, centre and right cabinet

Channel 3 operates (and dims) all the lights in light group 3, i.e. the bottom LED light panels in the left, centre and right cabinet

Notes:

The total wattage power of all lamps included per receiver must not exceed 30 W. The change of the colour temperature takes place for all lamps in all light groups.

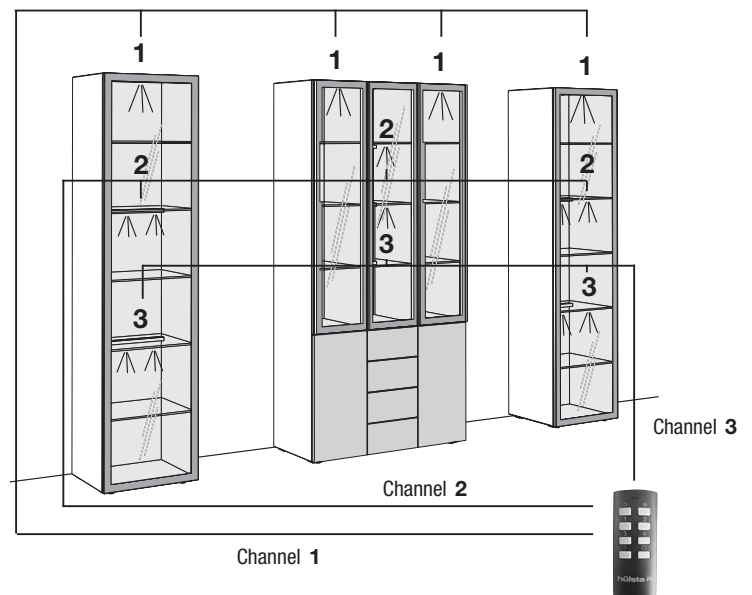

Special-sized products

FONIS

Special-sized products are possible on request.
Please get in touch with your customer advisor.

Special articles

Cover panels

for side and top panelling of fitted wardrobes (support construction and fitting materials must be acquired on site).

Basic price per order	9901	-
+ price per m ² in price group I	990	-
+ price per m ² in price group II	990	-
+ price per m ² in price group III	990	-

Veneer match with fronts can not be guaranteed.

Rim veneer

superimposed ex works or rims lacquered
for veneer and lacquer versions per m. length

in price group I	9902	-
in price group II	9902	-
in price group III	9902	-

Individual special-sized products

If the special-sized product that you require is so unusual that it cannot be illustrated with the many special sized products that we already provide and charge for, then we will quote you the price using a HK unit type factor. In your order please state for us the relevant enquiry number and the HK unit type factor stated.

HK -

Special colours; Note on „Blue Angel“ / Emissions label of DGM

Special colours

All the hülsta lacquer colours are possible for nearly all the hülsta ranges.
Availability and prices on request.

Note on „Blue Angel“ (RAL-UZ 38) and Emissions label of DGM (Class A)

It is possible that the requirements of the „Blue Angel“ and the DGM Emissions Label cannot be met by some of the lacquer colours in price groups II and III (see here the different lacquer versions in the NURIA range), depending on the colour mix (surface ratio of these colours in the corresponding order). However, the legal requirements are definitely met in all cases!

Wall composition / assembly instruction

Important notes:

The composition of walls must be ascertained before concluding a contract and be checked by a qualified fitter before assembly takes place.







Assembly may only be carried out by a qualified fitter under careful observation of the assembly instructions.

The plastic Rawl plugs supplied by hülsta as a standard set are only suitable for concrete $\geq C12/15$, if the wall composition and compression strength corresponds to the table below. Under no circumstances must a unit be assembled on light masonry.

Furthermore, we provide a mounting set with assembly mortar for the types of walls listed below (see assembly mortar set below). Again, assembly must be carried out by a qualified fitter under careful observation of the wall composition and assembly instruction. The compression strength levels stated below must be met under all circumstances.

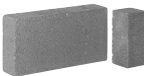
Materials table

with a description of which sets are to be used with the following types of walls:

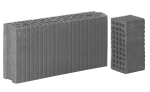
Standard set	Assembly mortar set only suitable for the materials stated below!	
Concrete C12/15 Compression strength $\geq 15 \text{ N/mm}^2$ 	 Building bricks Mz 12 Compression strength $\geq 12 \text{ N/mm}^2$	 Solid blocks of light concrete V2 Compression strength $\geq 2 \text{ N/mm}^2$
	 Limestone blocks KS 12 Compression strength $\geq 12 \text{ N/mm}^2$	 Perforated blocks of light concrete Hbl 2 Compression strength $\geq 2 \text{ N/mm}^2$
	 Perforated sand lime bricks KSL12 Compression strength $\geq 12 \text{ N/mm}^2$	 Aerated concrete PP2 Compression strength $\geq 2 \text{ N/mm}^2$
	 Vertically perforated bricks HLz 12 Compression strength $\geq 12 \text{ N/mm}^2$ Bulk density $\geq 1.0 \text{ kg/dm}^3$	

A different and more suitable type of mounting must be chosen by a qualified fitter in all other cases. hülsta cannot accept any responsibility for the choice of any other types of mounting! Please note that if the units are not mounted properly on the wall, there is a risk of the units falling down or tipping over – especially when alternative mounting materials acquired on site have been used. Generally speaking, you as a dealer/qualified fitter are responsible for the correct wall mounting of the units.



Mounting sets

Labelling in type list drawings / assembly notes for wall units

The majority of units have two wall mounting points (= number of support boards), if these are to be fitted as wall units. This is not explicitly mentioned in the type list. If a different number of wall mounting points (= support boards) is required, this is marked in the drawings in the type list with numbers in black boxes. Every support board requires four mounting screws.

- 3** = 3 support boards
- 4** = 4 support boards, etc.

One **assembly mortar set** is sufficient for up to a maximum of 3 support boards or 4 wall side-panels.

Important note: Depending on the composition of the wall (see wall types illustrated above), assembly must be carried out using the special assembly mortar set and a standard trade mastic tool which are the basic essentials for safe and clean workmanship.

Standard set

The standard set consists of 4 plastic Rawl plugs and 4 mounting screws and is sufficient for 1 support board. The standard sets are included in the packet of fittings to match the number of support boards.

Assembly mortar set for up to a maximum of 3 support boards consisting of:

- 9x injection retaining sleeve
- 9x screw-in sleeve
- 1x injection cartridge
- 2x static mixer
- 1x assembly instructions

Please use the mounting screws from the standard set (supplied free of charge).

Example of order:

- Add up number of support boards for all existing unit types
 - Divide the sum by “3”
 - Round up the result to a full number
- = Number of assembly mortar sets required

M2

-

Your Hotline to hülsta

Do you have any questions or require any alterations to your order confirmation?
Do you have any questions on our products or your current order?
Do you have any complaints about supplied goods or required replacement parts?
Contact Telephone: +49 (0) 2563 / 86-1144 • email: orders@huelsta.com

Do you have any questions, suggestions or wishes for the **hülsta Marketing team**
or the **hülsta product seminars**?
Contact Telephone: +49 (0) 2563 / 86-1611 • email: marketing@huelsta.com

hülsta Planning Service

Lots to do? A customer wants his project finished and you haven't got enough time? Or the project is so complex that it will take too much time?

This is exactly the kind of situation we created the hülsta Planning Service for. hülsta's employees create the required project for you at short notice. Based on your information, we implement the project perfectly with all views and a complete order list ready for immediate forwarding to the customer.

The hülsta check list (available at <https://hulsta.com/de/service/showroom/>) makes it all really easy for you. You won't forget anything with this list and the customer receives a project he will be thrilled about as quickly as possible.

hülsta Planning Service

Tel.: +49 (0) 2563 / 86-0

Fax: +49 (0) 2563 / 86-2666

Mail: Planungsservice-Handel@huelsta.de

Workdays from 8.00 a.m. until 6.00 p.m.

Special wishes? Come to us!

Maximum individuality! – Maximal flexibility! – hülsta makes most of your special wishes possible.

And if you do have a wish which is not quite so easy to implement, just give us a call or send us a mail or a fax. We have our own hülsta "Special Wishes Team" who are there to help you realise just these customer requests. These colleagues are professionals when it comes to special products. They plan and calculate the products possible for you and even develop an alternative suggestion if the idea should turn out to be technically impossible.

Here is an overview of the hülsta range of special wishes:

- A lot of special products can be ordered simply via the type list
- Special-sized products are planned simply and professionally
- Competent colleagues advise you by phone, by fax and by mail
- You will be sent alternative suggestions if the idea is technically impossible
- Many special-sized products are available without a surcharge
- Specially qualified carpenters and technicians implement your plans perfectly

hülsta Special Wishes Team

Tel.: +49 (0) 2563 / 86-0

Fax: +49 (0) 2563 / 86-1417

Mail: Sonderwunsch@huelsta.com

We are open Saturdays for you, too!

Our **Saturday hotline** is available all day from **10.00 a.m. until 6.00 p.m.**

Telephone: +49 (0) 2563 / 86-1800

On **working days** the hülsta Sales Department is available all day from **8.00 a.m. until 6.00 p.m.**

hülsta FONIS

Stand: E 6.2019

Design and concept legally protected, subject to error and alterations to construction, colour and materials by way of technological progress.

hülsta-werke · Karl-Hüls-Straße 1 · D-48703 Stadtlohn
Tel. +49 (0) 2563 / 86-0 · Fax +49 (0) 2563 / 86-1000
www.huelsta.com

hülsta 